

PATENT ASSIGNMENT

Electronic Version v1.1
 Stylesheet Version v1.1

SUBMISSION TYPE:	NEW ASSIGNMENT
NATURE OF CONVEYANCE:	ASSIGNMENT
CONVEYING PARTY DATA	
Name	Execution Date
Frank Alfred KAUER	08/12/2009
RECEIVING PARTY DATA	
Name:	Access Asia (H.K.) Limited
Street Address:	FLAT 2102, 21/F., BENSON TOWER, 74 HUNG TO ROAD, KWUN TONG
City:	KOWLOON
State/Country:	HONG KONG
PROPERTY NUMBERS Total: 1	
Property Type	Number
Application Number:	29342836
CORRESPONDENCE DATA	
Fax Number:	(484)920-1474
<i>Correspondence will be sent via US Mail when the fax attempt is unsuccessful.</i>	
Email:	patent@chinahk-ip.com
Correspondent Name:	YH CHAN
Address Line 1:	42 PIN OAKS DRIVE
Address Line 4:	PHOENIXVILLE, PENNSYLVANIA 19460
ATTORNEY DOCKET NUMBER:	29418
NAME OF SUBMITTER:	Frank Alfred KAUER
Total Attachments: 11 source=090901_29418_usa_assignment#page1.tif source=090901_29418_usa_assignment#page2.tif source=090901_29418_usa_assignment#page3.tif source=090901_29418_usa_assignment#page4.tif source=090901_29418_usa_assignment#page5.tif source=090901_29418_usa_assignment#page6.tif source=090901_29418_usa_assignment#page7.tif	

OP \$40.00 29342836

source=090901_29418_usa_assignment#page8.tif
source=090901_29418_usa_assignment#page9.tif
source=090901_29418_usa_assignment#page10.tif
source=090901_29418_usa_assignment#page11.tif

ASSIGNMENT

WHEREAS, I, Frank Alfred KAUER, of 2102, 21/F., Benson Tower, 74 Hung To Road, Kwun Tong, Kowloon, Hong Kong. Have made certain inventions which are described in an application for Letters Patent of the United States entitled "Football Helmet Popcorn Maker" executed by me on even date herewith preparatory to obtaining United States Letters Patent therefore, and

WHEREAS, Access Asia (H.K.) Limited, (hereinafter referred to as said Company), a HONG KONG corporation having a place of business at 2102, 21/F., Benson Tower, 74 Hung To Road, Kwun Tong, Kowloon, Hong Kong is desirous of acquiring the entire interest in said inventions throughout the United States of America and the territories thereof,

NOW, THEREFORE, for and in consideration of One Dollar (\$1.00) to me in hand paid, and other good and valuable consideration, receipt whereof is hereby acknowledged, I hereby sell, assign and transfer unto said Company, its successors and assigns, the entire right, title and interest throughout the United States of America and the territories thereof in and to said inventions, the aforesaid application, all other applications hereafter filed in the United States, based in whole or in part on said inventions, and all Letters Patents granted upon said applications by the United States, and I do hereby authorize and request the Commissioner of Patents to issue said Letters Patent to said Company. I further grant to said Company, its successors and assigns, the right to claim for any of said applications the full benefits and priority rights of any international agreement between the United States and any foreign country or countries.

I hereby warrant that I have the full right to make the conveyance herein, and I hereby covenant that I, my heirs, legal representatives and assigns, will when requested, communicate to said Company, its representatives, successors and assigns, all facts known respecting said inventions, execute all divisional, continuing, reissue, reexamination and foreign or international applications, together with individual assignments therefore, make all rightful oaths, sign all lawful papers, testify in any legal proceeding and generally do everything possible to aid said Company, its successors and assigns, in the obtaining of Letters Patent.

IN TESTIMONY WHEREOF, I have hereunto set our hands and seals at the location and on the date indicated with my signature.

Date: 12-18-61

Place: HONG KONG, CHINA.

.....
Frank Alfred KAUER

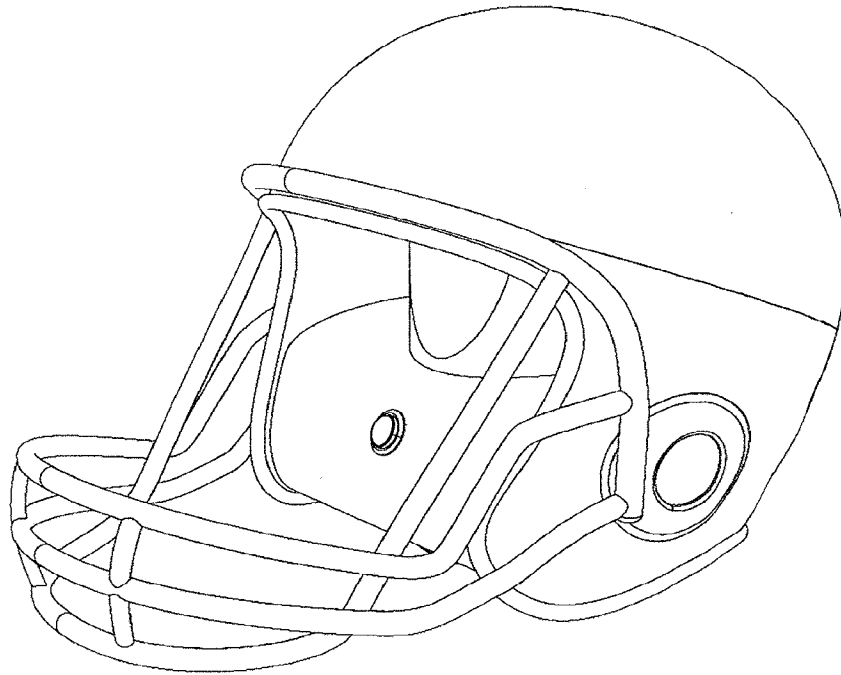

FIG. 1

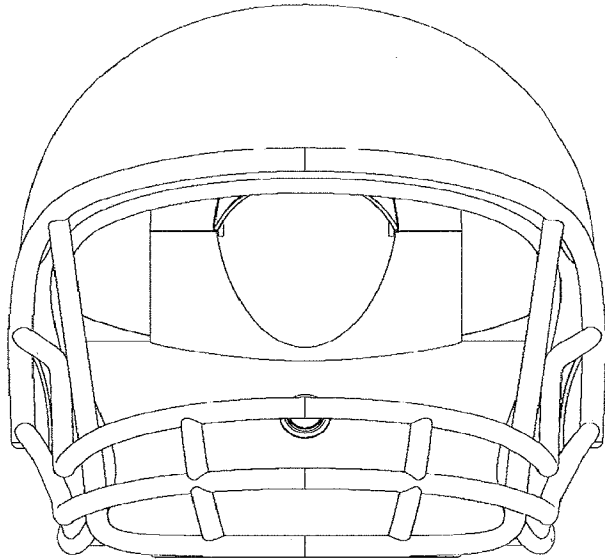

FIG. 2

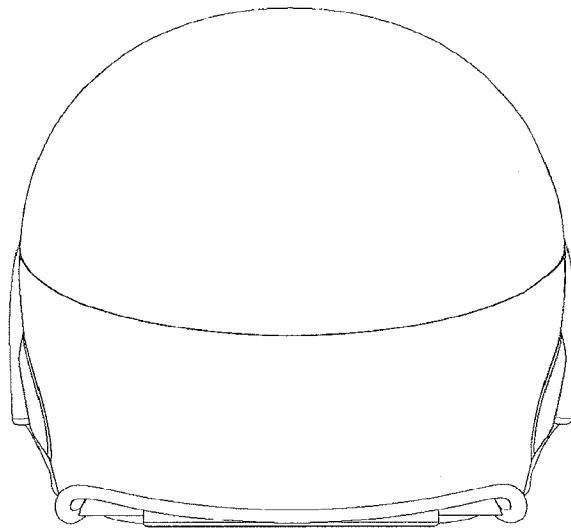

FIG. 3

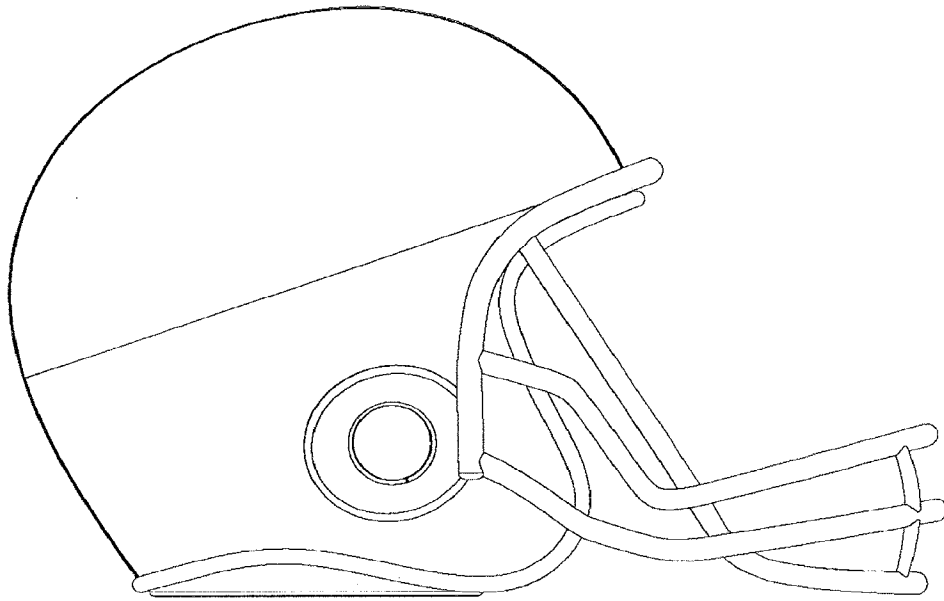

FIG. 4

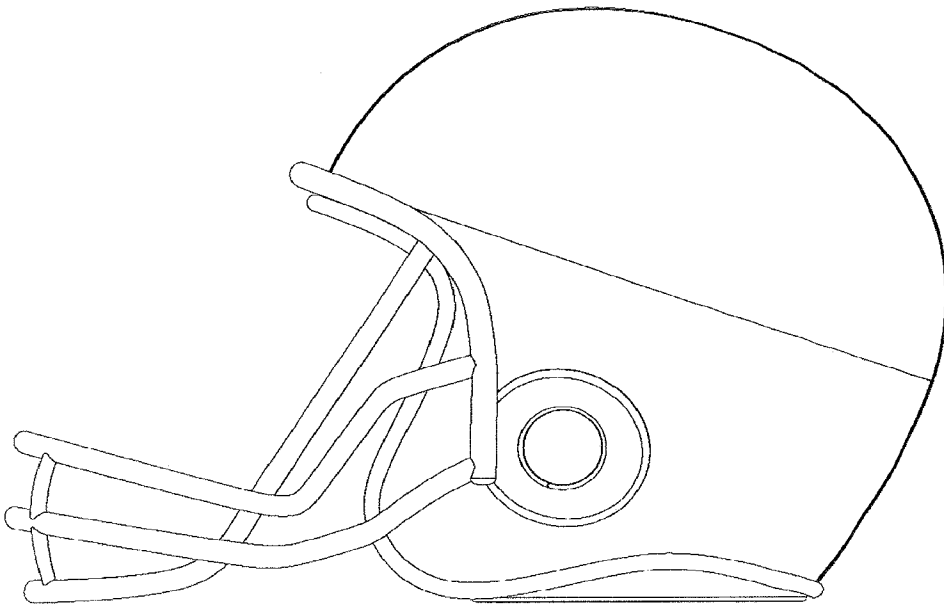

FIG. 5

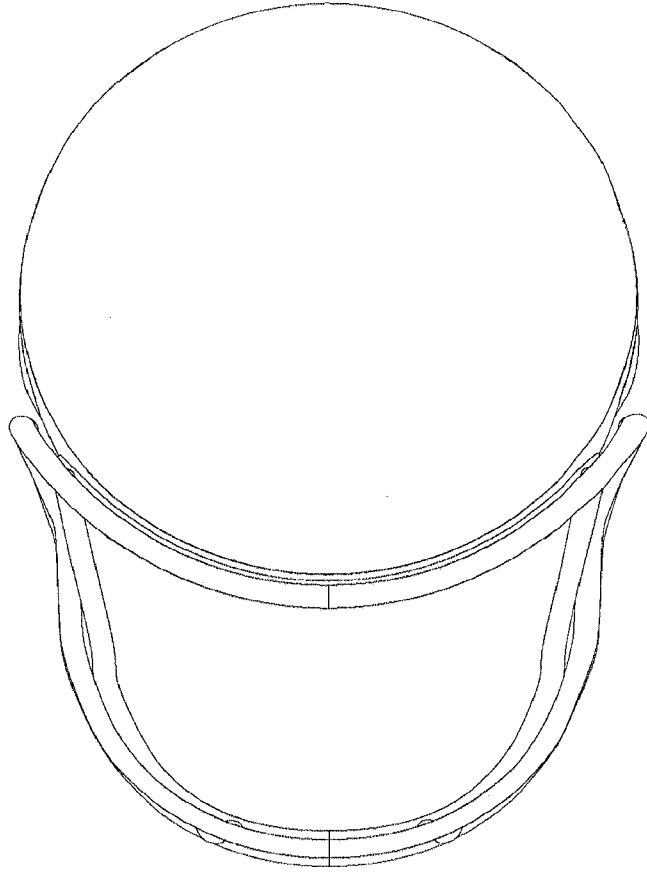

FIG. 6

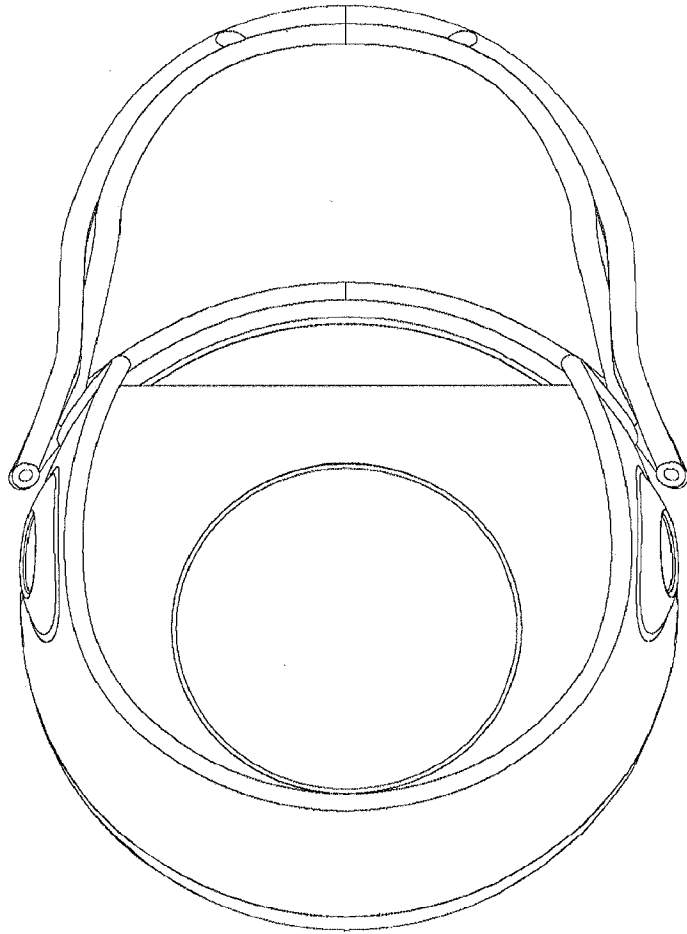

FIG. 7

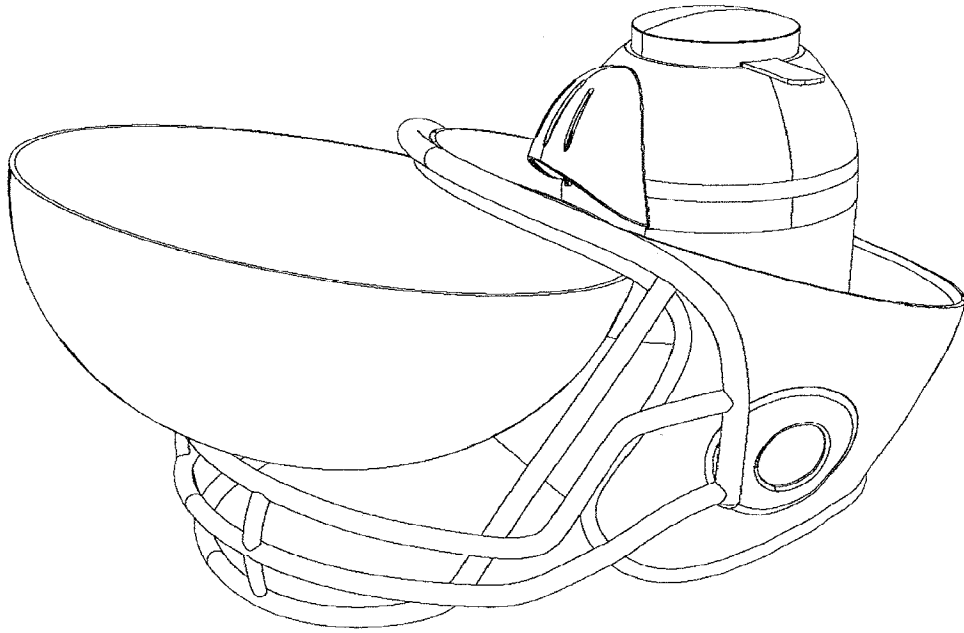

FIG. 8

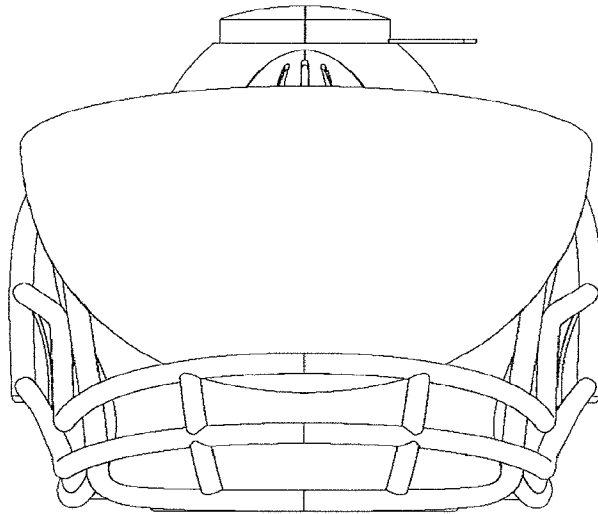

FIG. 9

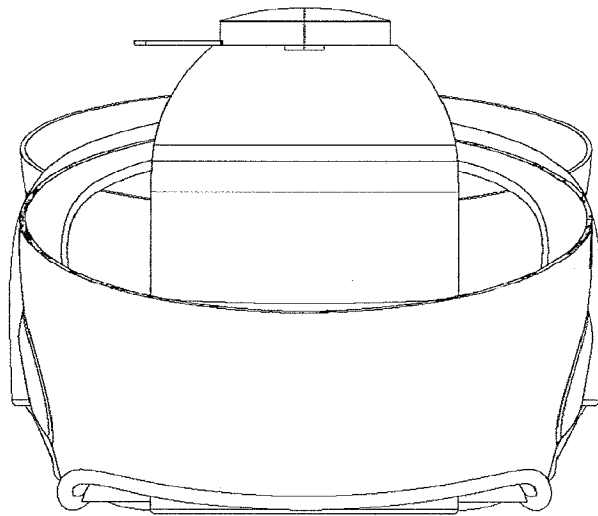

FIG. 10

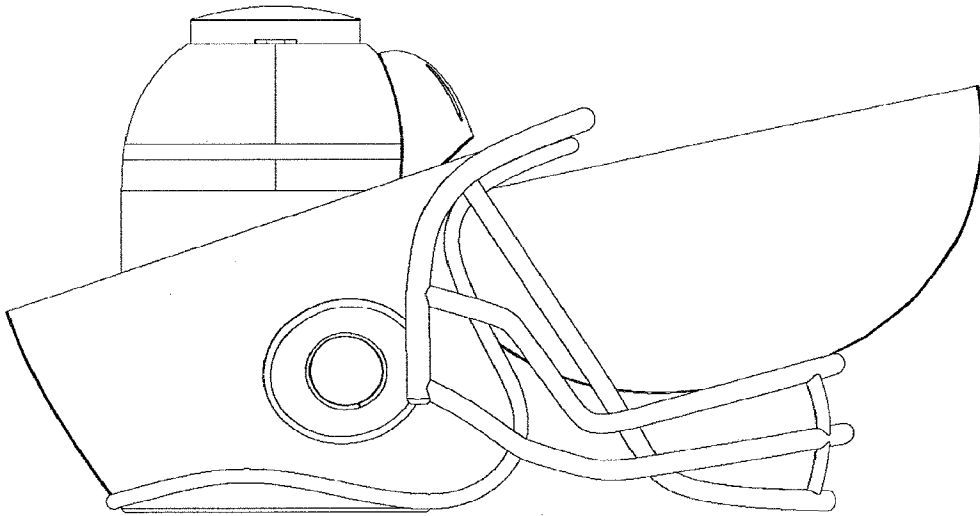

FIG. 11

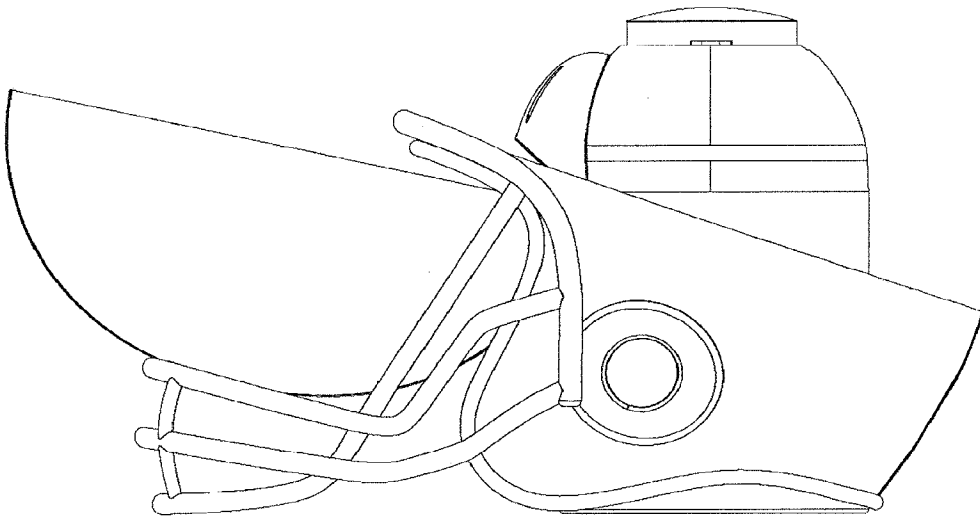

FIG. 12

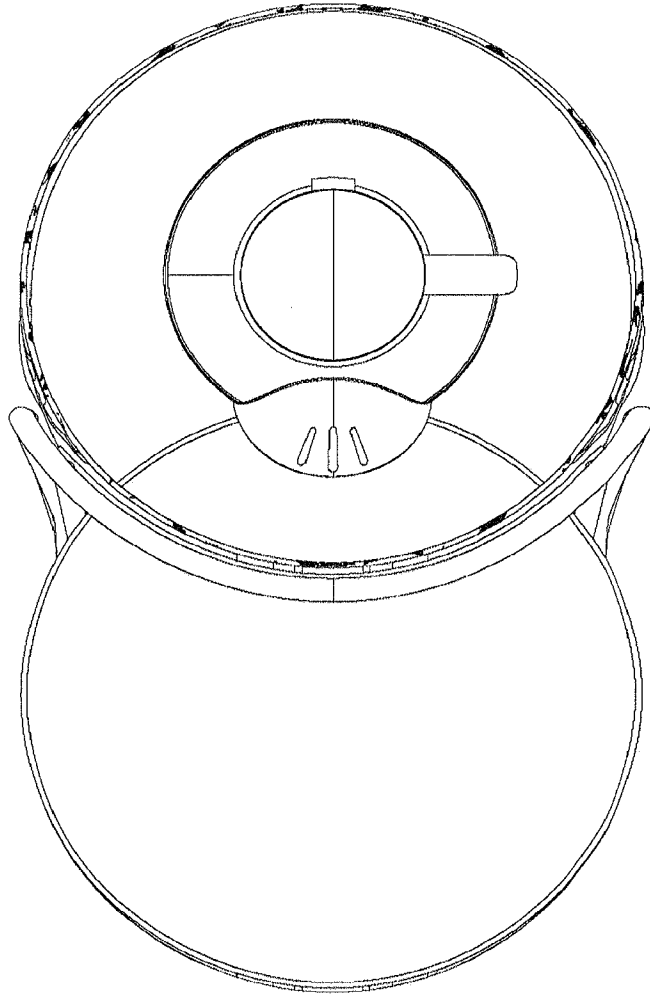

FIG. 13

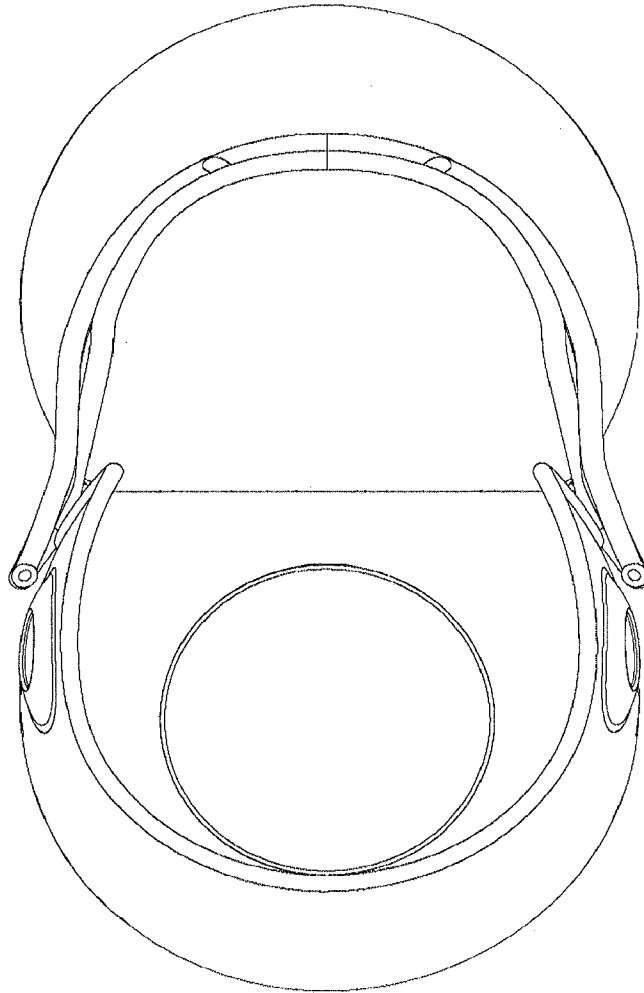

FIG. 14