

PATENT ASSIGNMENT COVER SHEET

Electronic Version v1.1
 Stylesheet Version v1.2

EPAS ID: PAT3121951

SUBMISSION TYPE:	NEW ASSIGNMENT
NATURE OF CONVEYANCE:	FIRST SUPPLEMENT TO GRANT OF SECURITY INTEREST IN UNITED STATES PATENTS

CONVEYING PARTY DATA

Name	Execution Date
RESTORATION HARDWARE, INC.	11/24/2014

RECEIVING PARTY DATA

Name:	BANK OF AMERICA, N.A., AS AGENT
Street Address:	100 FEDERAL STREET
City:	BOSTON
State/Country:	MASSACHUSETTS
Postal Code:	02110

PROPERTY NUMBERS Total: 42

Property Type	Number
Patent Number:	D686420
Patent Number:	D690527
Patent Number:	D687235
Patent Number:	D685200
Patent Number:	D686008
Patent Number:	D685202
Patent Number:	D703981
Patent Number:	D706783
Patent Number:	D707229
Patent Number:	D690456
Patent Number:	D687589
Patent Number:	D688409
Patent Number:	D664782
Patent Number:	D651012
Patent Number:	D663966
Patent Number:	D663967
Patent Number:	D688485
Patent Number:	D688486
Patent Number:	D692249
Patent Number:	D673386

PATENT

Property Type	Number
Patent Number:	D691825
Patent Number:	D692250
Patent Number:	D677924
Patent Number:	D660045
Patent Number:	D667653
Patent Number:	D674214
Patent Number:	D674217
Patent Number:	D660046
Patent Number:	D667654
Patent Number:	D660613
Patent Number:	D665189
Patent Number:	D665194
Patent Number:	D677933
Patent Number:	D678590
Patent Number:	D673713
Patent Number:	D678591
Patent Number:	D659278
Patent Number:	D660499
Patent Number:	D674535
Application Number:	29429749
Application Number:	29501758
Application Number:	29503012

CORRESPONDENCE DATA

Fax Number: (800)494-7512

Correspondence will be sent to the e-mail address first; if that is unsuccessful, it will be sent using a fax number, if provided; if that is unsuccessful, it will be sent via US Mail.

Phone: 202-370-4750

Email: ipteam@nationalcorp.com

Correspondent Name: DARLENA BARI STARK

Address Line 1: 1025 VERMONT AVE NW, SUITE 1130

Address Line 2: NATIONAL CORPORATE RESEARCH, LTD.

Address Line 4: WASHINGTON, D.C. 20005

ATTORNEY DOCKET NUMBER:	F152779
NAME OF SUBMITTER:	ANDREW NASH
SIGNATURE:	/ANDREW NASH/
DATE SIGNED:	11/25/2014

Total Attachments: 14

source=FINAL (10th A&R) - Supplement to Patent IPSA - Restoration#page1.tif

source=FINAL (10th A&R) - Supplement to Patent IPSA - Restoration#page2.tif

source=FINAL (10th A&R) - Supplement to Patent IPSA - Restoration#page3.tif
source=FINAL (10th A&R) - Supplement to Patent IPSA - Restoration#page4.tif
source=FINAL (10th A&R) - Supplement to Patent IPSA - Restoration#page5.tif
source=FINAL (10th A&R) - Supplement to Patent IPSA - Restoration#page6.tif
source=FINAL (10th A&R) - Supplement to Patent IPSA - Restoration#page7.tif
source=FINAL (10th A&R) - Supplement to Patent IPSA - Restoration#page8.tif
source=FINAL (10th A&R) - Supplement to Patent IPSA - Restoration#page9.tif
source=FINAL (10th A&R) - Supplement to Patent IPSA - Restoration#page10.tif
source=FINAL (10th A&R) - Supplement to Patent IPSA - Restoration#page11.tif
source=FINAL (10th A&R) - Supplement to Patent IPSA - Restoration#page12.tif
source=FINAL (10th A&R) - Supplement to Patent IPSA - Restoration#page13.tif
source=FINAL (10th A&R) - Supplement to Patent IPSA - Restoration#page14.tif

FIRST SUPPLEMENT TO GRANT OF SECURITY INTEREST
IN UNITED STATES PATENTS

This Supplement to Grant of Security Interest in United States Patents (this "Grant") is made as of the 24th day of November, 2014 by **RESTORATION HARDWARE, INC.**, a Delaware corporation (the "Grantor") in favor of **BANK OF AMERICA, N.A.**, as Agent (the "Grantee").

WHEREAS, Grantor executed and delivered a Grant of Security Interest in United States Patents dated August 3, 2011 and recorded on August 5, 2011 at Reel 026708, Frame 0083 (as amended of record from time to time, hereinafter, the "Original Grant") in favor of the Grantee, pursuant to which Grantor pledged, assigned and granted a security interest in certain Patents and/or Patent Applications (as defined therein); and

WHEREAS, the Grantor developed additional Patents and desires to hereby confirm the pledge of, and the grant of a security interest in, such additional Patents in favor of the Grantee.

NOW, THEREFORE, in consideration of the mutual covenants herein contained and benefits to be derived herefrom, it is hereby agreed as follows:

1. Definitions. All capitalized terms herein and not otherwise defined shall have the same meaning herein as in the Original Grant.
2. Supplement to Schedule A. Schedule A to the Original Grant is hereby supplemented, but not replaced, by Schedule A-1 annexed hereto.
3. Miscellaneous:
 - a. Except as provided herein, all terms and conditions of the Original Grant remain in full force and effect. The Grantor hereby ratifies, confirms and reaffirms all of the representations, warranties and covenants contained therein.
 - b. This Grant and the Original Grant cover the entire understanding of the parties with respect to the matters set forth herein and supersede all prior discussions and negotiations hereon.

[signature pages follow]

IN WITNESS WHEREOF, the undersigned has executed this Grant to be duly executed as of the date set forth above.

RESTORATION HARDWARE, INC.

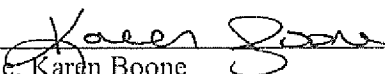
By: 
Name: Karen Boone
Title: Chief Financial and Administrative Officer



Signature Page to Patent Security Agreement



PATENT
REEL: 034455 FRAME: 0060

BANK OF AMERICA, N.A., as Agent and
Grantee

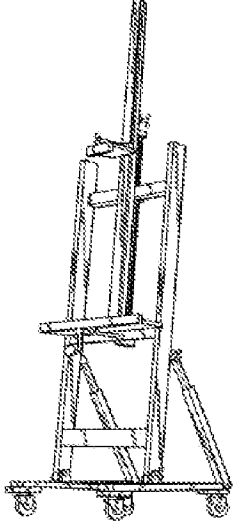
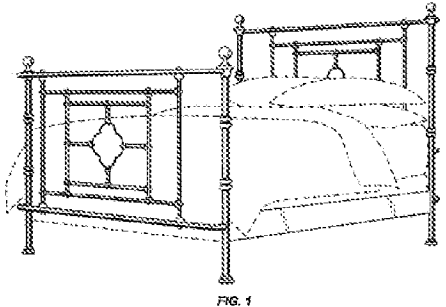
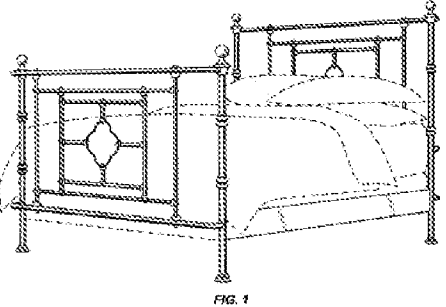
By: 
Name: Roger G. Malouf
Title: Director

SCHEDULE A-1

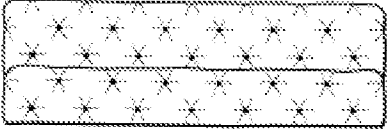
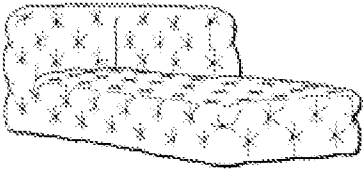
Title	App. No.	Filing Date	Patent No.	Issue Date	Figure
Easel	29/429,747	8/15/2012	D686,420	7/23/2013	 <p align="center">FIG. 1</p>
Bed	149738	2/12/2013	149738	3/26/2014	 <p align="center">FIG. 1</p>
Bed	29/429,555	8/13/2012	D690,527	10/1/2013	 <p align="center">FIG. 1</p>
Sofa	29/429,560	8/13/2012	D687,235	8/6/2013	 <p align="center">FIG. 1</p>

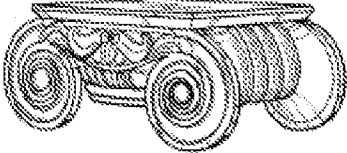
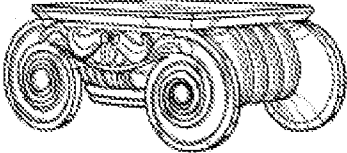
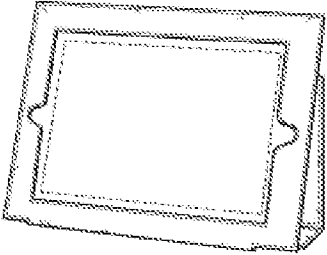

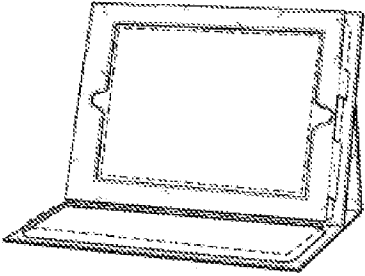
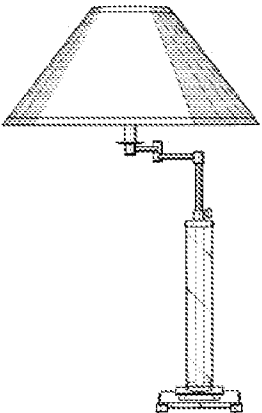
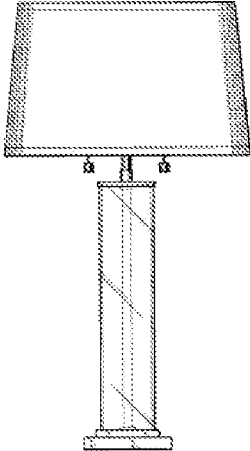
Title	App. No.	Filing Date	Patent No.	Issue Date	Figure
Armless Sofa	29/429,558	8/13/2012	D685,200	7/2/2013	 <p data-bbox="1208 453 1273 478">FIG. 1</p>
One Arm Chaise	29/429,557	8/13/2012	D686,008	7/16/2013	 <p data-bbox="1208 674 1273 699">FIG. 1</p>
One Arm Loveseat	29/429,556	8/13/2012	D685,202	7/2/2013	 <p data-bbox="1159 856 1224 882">FIG. 1</p>
Table	149736	2/12/2013	149736	1/15/2014	 <p data-bbox="1040 989 1105 1014">FIG. 1</p>
Table	29/429,562	8/13/2012	D703,981	5/6/2014	 <p data-bbox="1040 1182 1105 1207">FIG. 1</p>
Electronic Device Cover	29/429,751	8/15/2012	D706,783	6/10/2014	 <p data-bbox="1175 1556 1240 1581">FIG. 1</p>

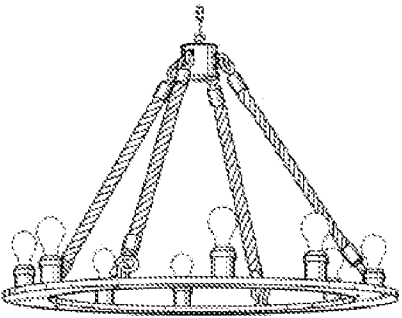
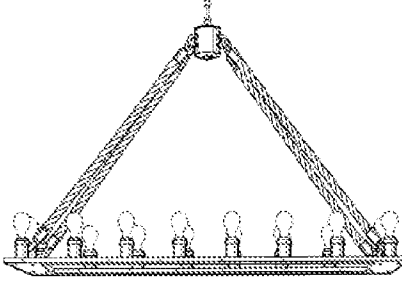
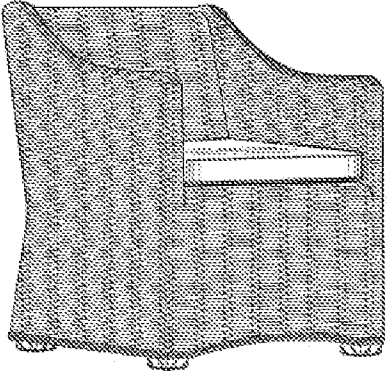
Title	App. No.	Filing Date	Patent No.	Issue Date	Figure
Electronic Device Cover	29/429,752	8/15/2012	D707,229	6/7/2014	 <p data-bbox="1198 611 1252 632">FIG. 1</p>
Lamp	29/429,749	8/15/2012			 <p data-bbox="1170 1094 1208 1115">FIG. 1</p>
Lamp	29/429,750	8/15/2012	D690,456	9/24/2013	 <p data-bbox="1154 1619 1208 1640">FIG. 1</p>

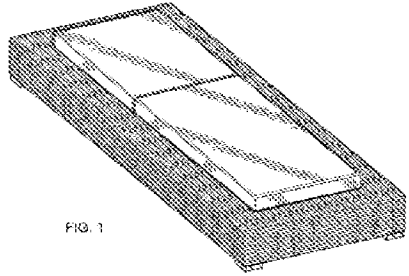
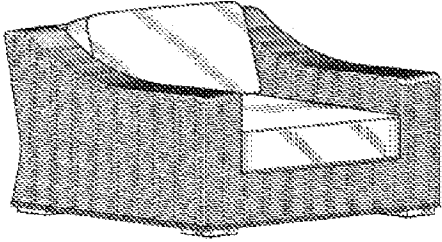
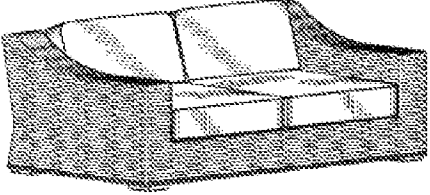
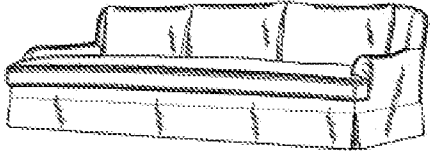
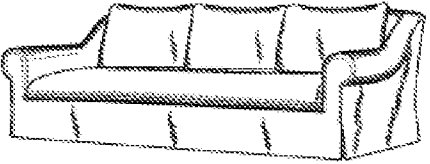
Title	App. No.	Filing Date	Patent No.	Issue Date	Figure
Chandelier	29/429,734	8/15/2012	D687,589	8/6/2013	 <p data-bbox="1224 688 1273 709">FIG. 1</p>
Chandelier	29/429,736	8/15/2012	D688,409	8/20/2013	 <p data-bbox="1240 1058 1273 1079">FIG. 1</p>
Armchair	29/386,266	2/25/2011	D664,782	8/7/2012	 <p data-bbox="1230 1528 1289 1549">FIG. 1</p>

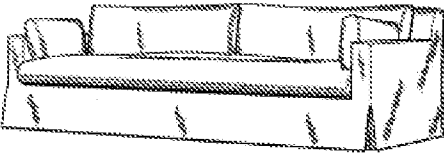
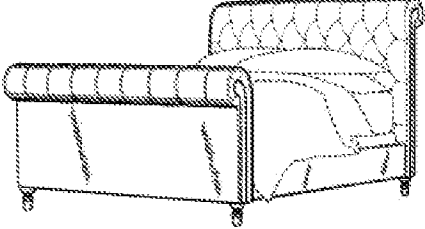
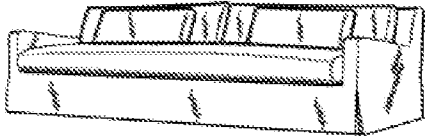
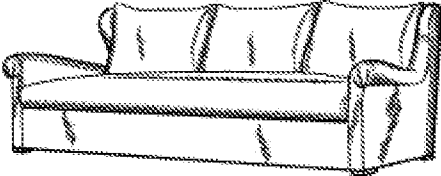
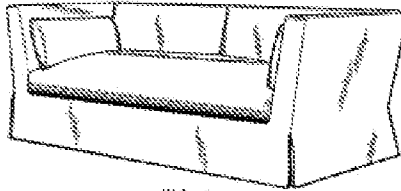
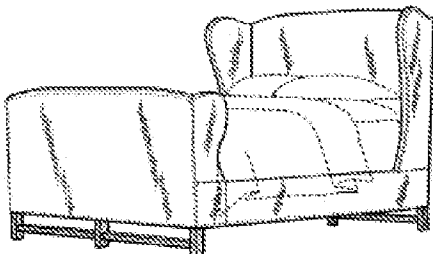
Title	App. No.	Filing Date	Patent No.	Issue Date	Figure
Chaise	29/386,268	2/25/2011	D651,012	12/27/2011	 <p data-bbox="1112 527 1156 541">FIG. 1</p>
Lounge	29/386,269	2/25/2011	D663,966	7/24/2012	 <p data-bbox="1219 919 1268 934">FIG. 1</p>
Sofa	29/386,270	2/25/2011	D663,967	7/24/2012	 <p data-bbox="1268 1199 1325 1213">FIG. 1</p>
Sofa	29/399,154	8/10/2011	D688,485	8/7/2013	 <p data-bbox="1256 1457 1313 1472">FIG. 1</p>
Sofa	29/399,160	8/10/2011	D688,486	8/27/2013	 <p data-bbox="1240 1709 1297 1724">FIG. 1</p>

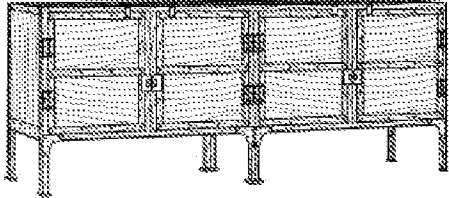
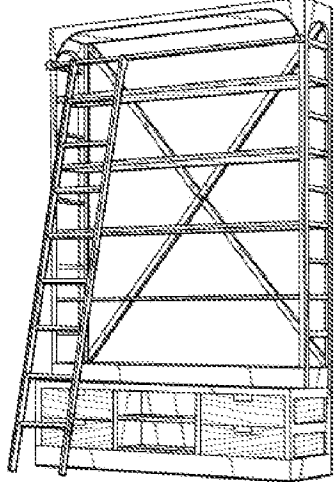
Title	App. No.	Filing Date	Patent No.	Issue Date	Figure
Sofa	29/399,167	8/10/2011	D692,249	10/9/2013	 <p data-bbox="1240 474 1292 495">FIG. 1</p>
Bed	29/399,187	8/10/2011	D673,386	1/1/2013	 <p data-bbox="1252 810 1304 831">FIG. 1</p>
Sofa	29/399,174	8/10/2011	D691,825	10/2/2013	 <p data-bbox="1235 993 1287 1014">FIG. 1</p>
Sofa	29/399,177	8/10/2011	D692,250	10/29/2013	 <p data-bbox="1235 1209 1287 1230">FIG. 1</p>
Sofa	29/399,181	8/10/2011	D677,924	3/19/2013	 <p data-bbox="1211 1440 1268 1461">FIG. 1</p>
Bed	29/399,189	8/10/2011	D660,045	5/22/2012	 <p data-bbox="1252 1776 1304 1797">FIG. 1</p>

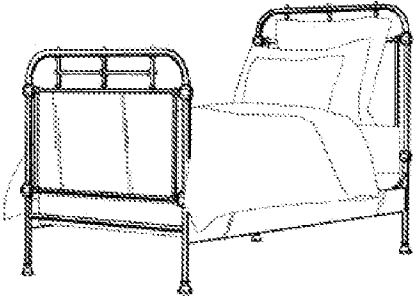
Title	App. No.	Filing Date	Patent No.	Issue Date	Figure
Console	29/399,193	8/10/2011	D667,653	9/25/2012	 <p data-bbox="1252 512 1305 533">FIG. 1</p>
Shelving	29/399,869	8/19/2011	D674,214	1/15/2013	 <p data-bbox="1208 1062 1252 1083">FIG. 1</p>
Table	29/399,704	8/17/2011	D674,217	1/15/2013	 <p data-bbox="1247 1260 1291 1281">FIG. 1</p>
Bed	29/399,713	8/17/2011	D660,046	5/22/2012	 <p data-bbox="1240 1631 1291 1652">FIG. 1</p>

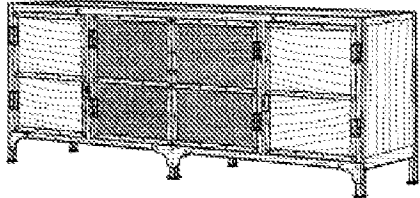
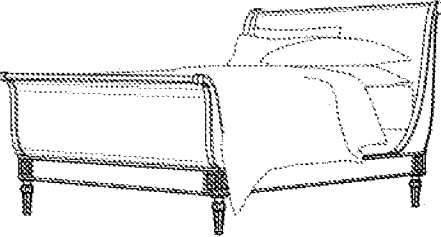
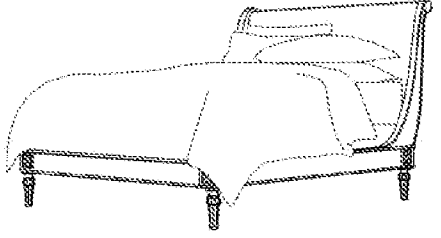
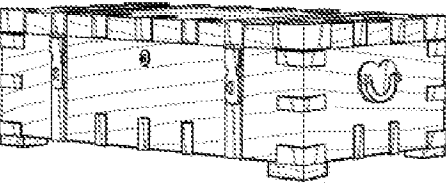
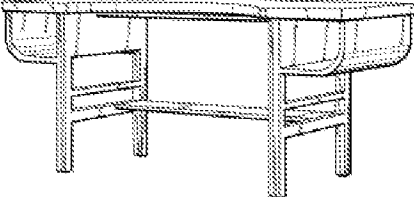
Title	App. No.	Filing Date	Patent No.	Issue Date	Figure
Console	29/399,805	8/18/2011	D667,654	9/25/2012	 <p data-bbox="1235 506 1289 527">FIG. 1</p>
Bed	29/399,809	8/18/2011	D660,613	5/29/2012	 <p data-bbox="1268 852 1312 873">FIG. 1</p>
Bed	29/399,810	8/18/2011	D665,189	8/14/2012	 <p data-bbox="1247 1136 1291 1157">FIG. 1</p>
Table	29/399,813	8/18/2011	D665,194	8/14/2012	 <p data-bbox="1230 1409 1274 1430">FIG. 1</p>
Desk	29/399,816	8/18/2011	D677,933	3/19/2013	 <p data-bbox="1219 1661 1263 1682">FIG. 1</p>

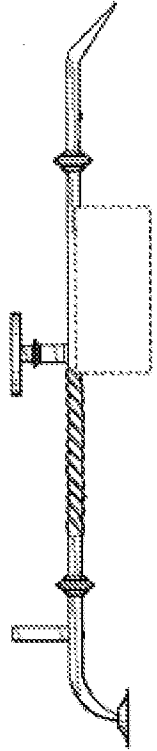
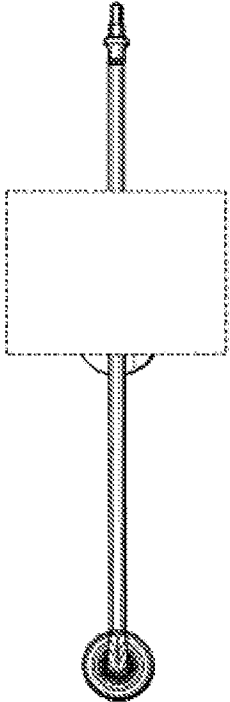
Title	App. No.	Filing Date	Patent No.	Issue Date	Figure
Sconce	29/399,874	8/19/2011	D678,590	3/19/2013	 <p data-bbox="1117 1060 1182 1087">FIG. 1</p>
Sconce	29/399,876	8/19/2011	D673,713	1/1/2013	 <p data-bbox="1144 1816 1209 1843">FIG. 1</p>

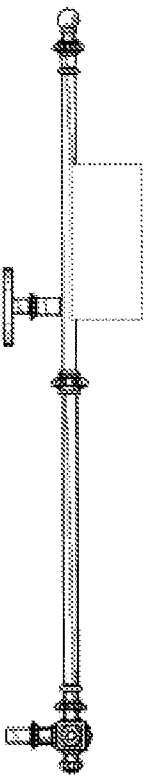
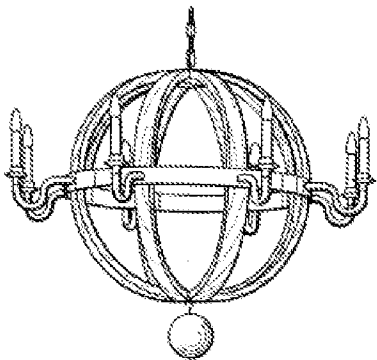
Title	App. No.	Filing Date	Patent No.	Issue Date	Figure
Sconce	29/399,877	8/19/2011	D678,591	3/19/2013	 <p data-bbox="1120 1087 1185 1117">FIG. 1</p>
Chandelier	29/399,879	8/19/2011	D659,278	5/8/2012	 <p data-bbox="1218 1522 1282 1551">FIG. 1</p>

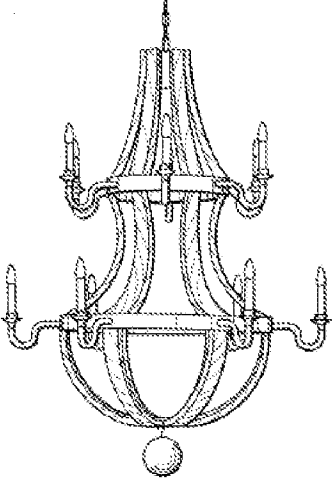
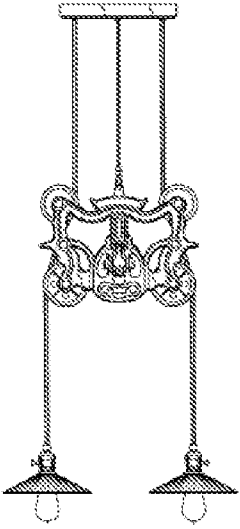
Title	App. No.	Filing Date	Patent No.	Issue Date	Figure
Chandelier	29/399,880	8/19/2011	D660,499	5/22/2012	 <p data-bbox="1198 806 1243 825">FIG. 1</p>
Lamp	29/399,818	8/18/2011	D674,535	1/15/2013	 <p data-bbox="1154 1388 1201 1407">FIG. 1</p>
Illuminated Snow Globe	29/501,758	9/8/2014			
Illuminated Snow Globe	158933	9/26/2014			
Snow Globe with Image	29/503,012	9/22/2014			
Snow Globe with Image	158932	9/26/2014			