

## PATENT ASSIGNMENT COVER SHEET

Electronic Version v1.1  
Stylesheet Version v1.2

EPAS ID: PAT3845884

<b>SUBMISSION TYPE:</b>	NEW ASSIGNMENT
<b>NATURE OF CONVEYANCE:</b>	ASSIGNMENT
<b>CONVEYING PARTY DATA</b>	
<b>Name</b>	<b>Execution Date</b>
MY T. NGUYEN	06/17/2015
CHRISTINA M. NGUYEN	06/17/2015
<b>RECEIVING PARTY DATA</b>	
<b>Name:</b>	RYNAN TECHNOLOGIES PTE LTD.
<b>Street Address:</b>	10 KALLANG AVENUE, UNIT #05-10
<b>Internal Address:</b>	APERIA TOWER 2
<b>City:</b>	SINGAPORE
<b>State/Country:</b>	SINGAPORE
<b>Postal Code:</b>	339510
<b>PROPERTY NUMBERS Total: 3</b>	
<b>Property Type</b>	<b>Number</b>
Application Number:	29549471
Application Number:	29549508
Application Number:	29549520
<b>CORRESPONDENCE DATA</b>	
<b>Fax Number:</b>	(952)912-0574
<i>Correspondence will be sent to the e-mail address first; if that is unsuccessful, it will be sent using a fax number, if provided; if that is unsuccessful, it will be sent via US Mail.</i>	
<b>Phone:</b>	9522534106
<b>Email:</b>	jarmstrong@alteralaw.com
<b>Correspondent Name:</b>	ALTERA LAW GROUP, LLC
<b>Address Line 1:</b>	121 SOUTH 8TH STREET, SUITE 650
<b>Address Line 4:</b>	MINNEAPOLIS, MINNESOTA 55402
<b>NAME OF SUBMITTER:</b>	MICHAEL B. LASKY
<b>SIGNATURE:</b>	/Michael Lasky/
<b>DATE SIGNED:</b>	04/26/2016
<b>Total Attachments: 22</b>	
source=Assignment3#page1.tif	
source=Assignment3#page2.tif	
source=Assignment3#page3.tif	

source=Assignment3#page4.tif  
source=Assignment3#page5.tif  
source=Assignment3#page6.tif  
source=Assignment3#page7.tif  
source=Assignment3#page8.tif  
source=Assignment3#page9.tif  
source=Assignment3#page10.tif  
source=Assignment3#page11.tif  
source=Assignment3#page12.tif  
source=Assignment3#page13.tif  
source=Assignment3#page14.tif  
source=Assignment3#page15.tif  
source=Assignment3#page16.tif  
source=Assignment3#page17.tif  
source=Assignment3#page18.tif  
source=Assignment3#page19.tif  
source=Assignment3#page20.tif  
source=Assignment3#page21.tif  
source=Assignment3#page22.tif

ASSIGNMENTS OF INDUSTRIAL DESIGN

UNIVERSAL

WHEREAS, I/We, 1) My T. Nguyen, whose full address is Long Tri Hamlet, Long Duc Ward, Tra Vinh City, Travinh, Vietnam; 2) Christina M. Nguyen, whose full address is 3/01 Scott St, Apt 204, San Francisco, USA; have designed Smart Padlocks as summarily illustrated in Annex "A" described in design applications Nos. See below filed on \_\_\_\_\_ I/We hereby authorize and request my/our patent agent to insert missing information above and information regarding any additional application(s) covering the same industrial designs and invention when known here in parentheses (Country United States Application number 29/549471, filed 12/22/2015; Country United States Application number 29/549508 filed 12/22/2015; Country United States Application number 29/549520, filed on 12/22/2015).

and:

10 Kallang Avenue, Agency Tower 2, Office #05-10, Singapore 339510

WHEREAS RYNAN TECHNOLOGIES PTE. LTD., whose full post office address is Agency Tower 2B & 10, Kallang Avenue, Office 15-10 Kallang-Singapore (hereinafter referred to as the Assignee), is desirous of acquiring my/our entire right, title and interest in and to said industrial designs, invention or inventions and in and to any and all industrial design registrations and all patents to be obtained therefor;

NOW, THEREFORE, in consideration of One Dollar (\$1.00) and other valuable consideration, the receipt of which is hereby acknowledged, I/We have and by these present do hereby sell, assign and transfer unto said Assignee, its successors and assigns, my/our entire right, title and interest in and to said industrial designs and invention or inventions, as described in the aforesaid application(s), in any form or embodiment thereof, and in and to the aforesaid applications; and in and to any applications based thereon filed in any foreign country, including the right to file said foreign applications under the provisions of the Patent Cooperation Treaty and under the Paris Convention; also my/our entire right, title and interest in and to any and all industrial designs and all patents, reissues or extensions thereof to be obtained in this or any foreign country upon said industrial designs, invention or inventions, and any divisional, continuation, continuation-in-part, substitute application(s) or supplementary disclosure(s) which may be filed upon said industrial designs and invention or inventions, in any country; and I/We

hereby authorize and request the issuing authority to issue any and all industrial designs and all patents on said applications or applications to said Assignee.

I/We further agree without any payment by said Assignee other than expenses incurred by the undersigned, to communicate to said Assignee, its representatives or agents, any facts useful as evidence for interference purposes or for other proceedings relating to intellectual property encompassing the industrial designs and the invention, whenever requested; testify in any interference, litigation or other proceedings, whenever requested; and execute and deliver, on request, all lawful papers required to make any of the foregoing provisions effective, and likewise make these provisions binding upon my/our heirs, legal representatives, administrators and assigns.

Les soussignés désirent que la présente cession soit en anglais. The undersigned request that the present assignment be in English.

IN WITNESS WHEREOF, I/We have hereunto set my/our hand(s) and seal.

WITNESS(ES)

DATE

ASSIGNOR(S)

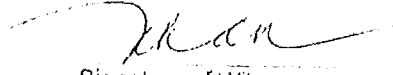

Signature of Witness

6/17/2015  
MM/DD/YYYY

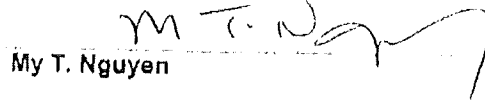

My T. Nguyen

Nhan Bui  
Name of Witness



Signature of Witness

6/17/2015  
MM/DD/YYYY

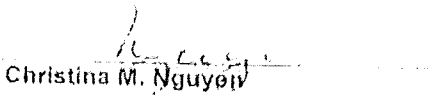

Christina M. Nguyen

NAPOLEON TA  
Name of Witness

WITNESS(ES)

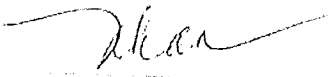

Signature of Witness

Nhan Bui  
Name of Witness

DATE

6/11/2009  
MM/DD/YYYY

ASSIGNEE

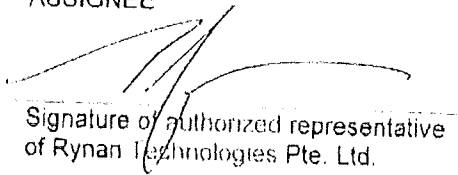
  
Signature of authorized representative  
of Ryan Technologies Pte. Ltd.

ANNEX « A »

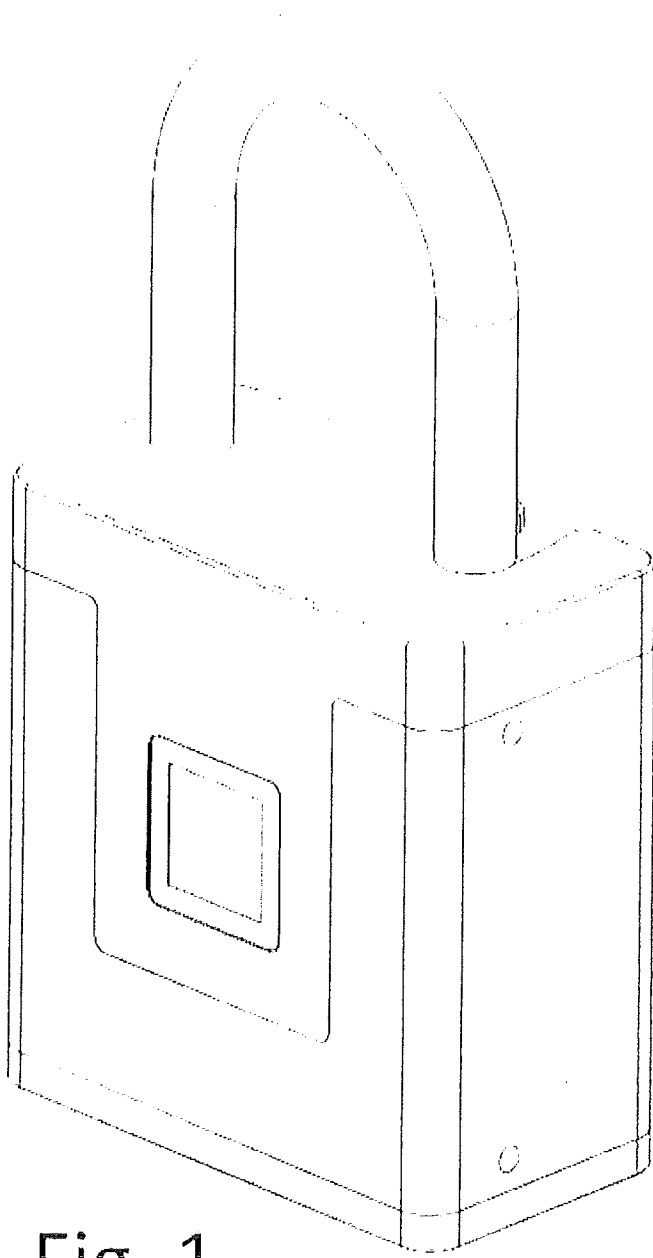

Fig. 1

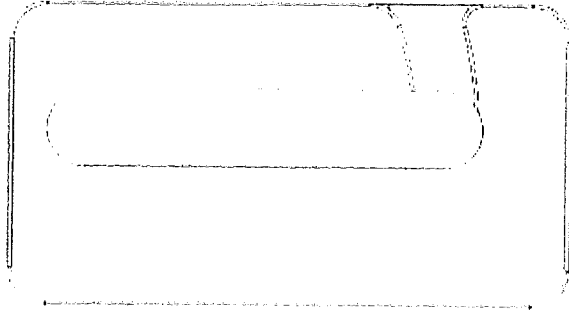

Fig. 2

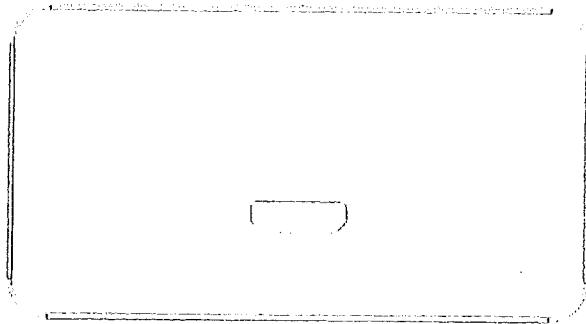

Fig. 3



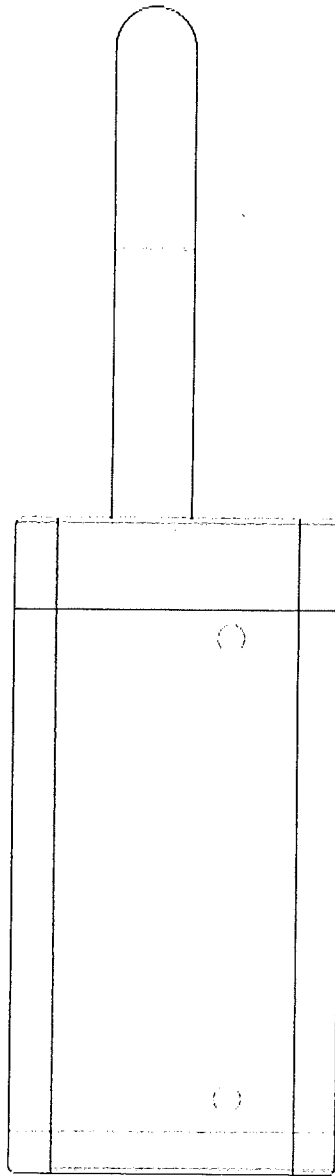

Fig. 4

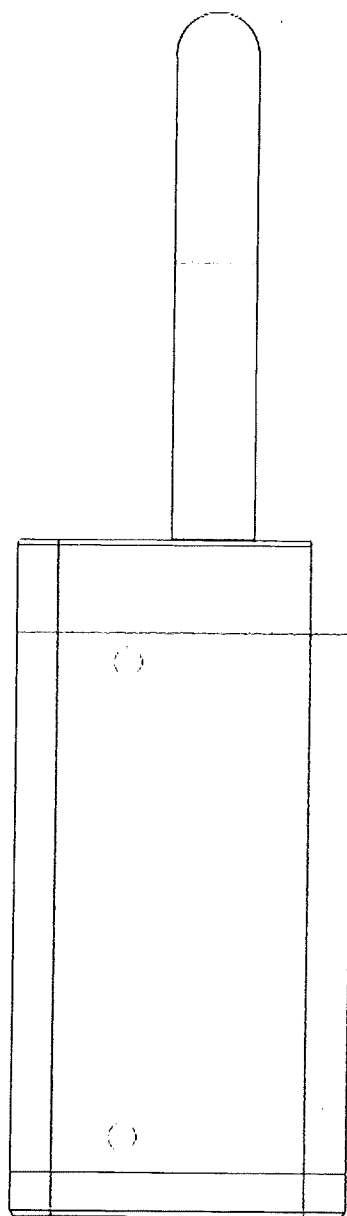

Fig. 5

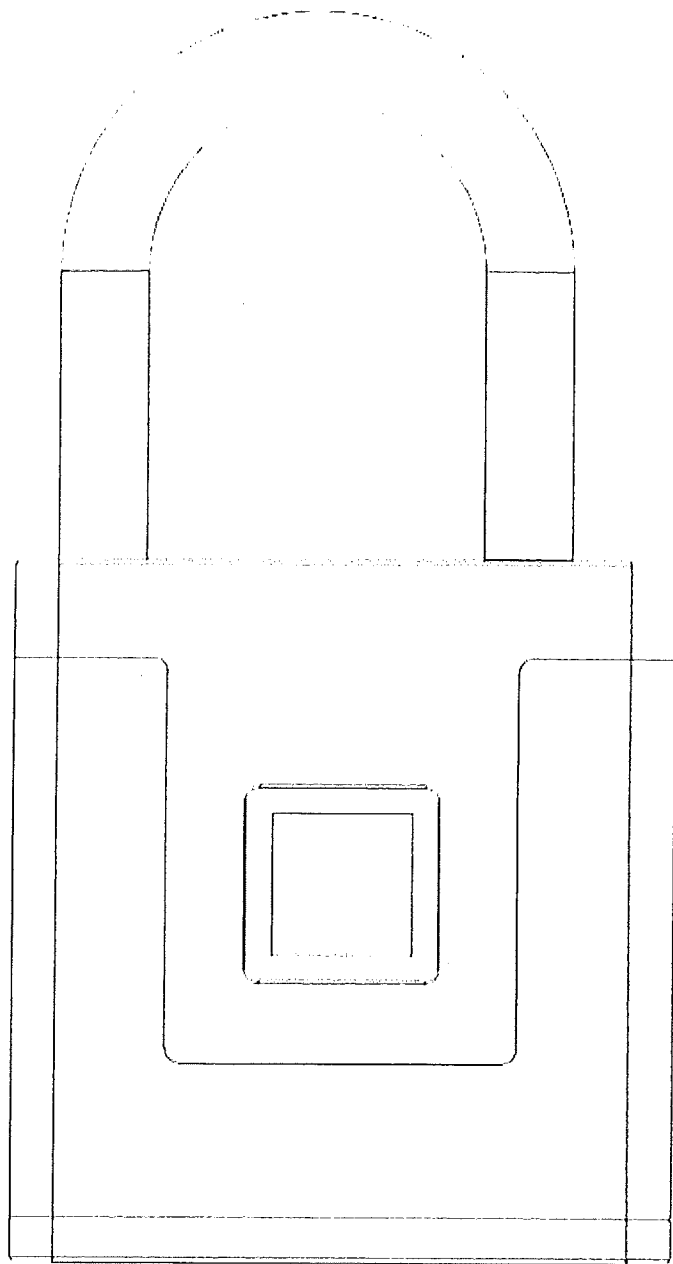

Fig. 6

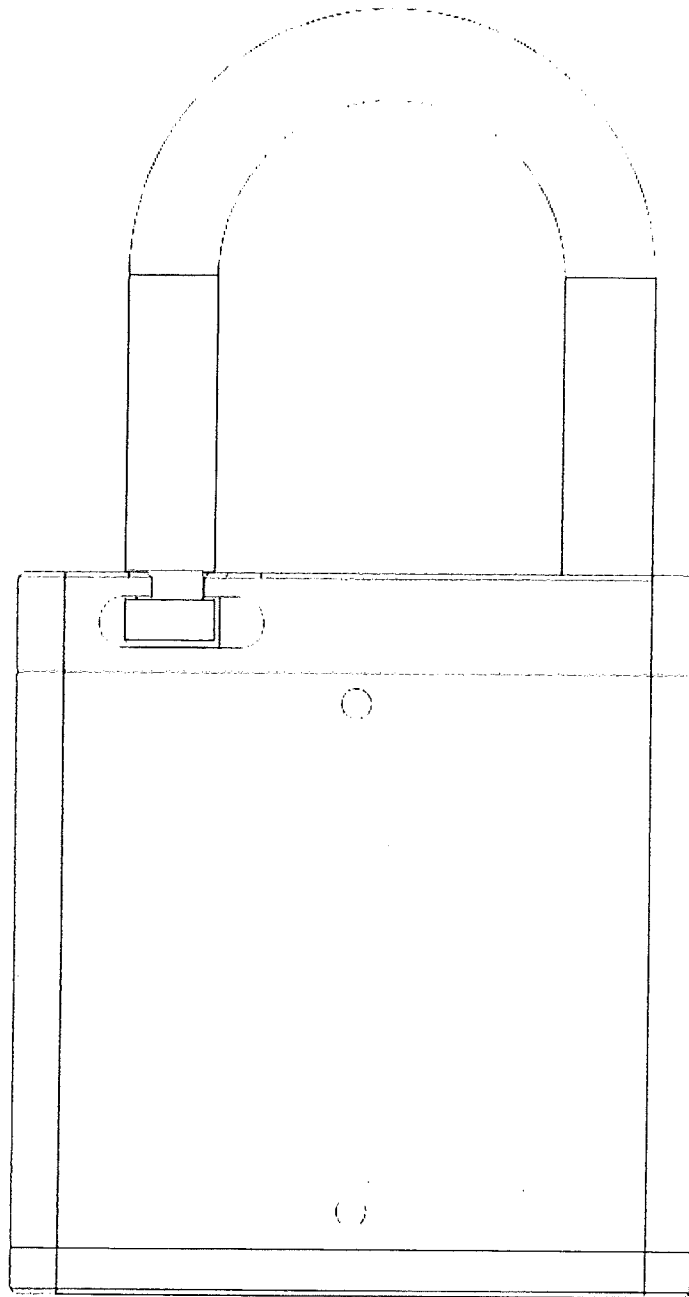

Fig. 7

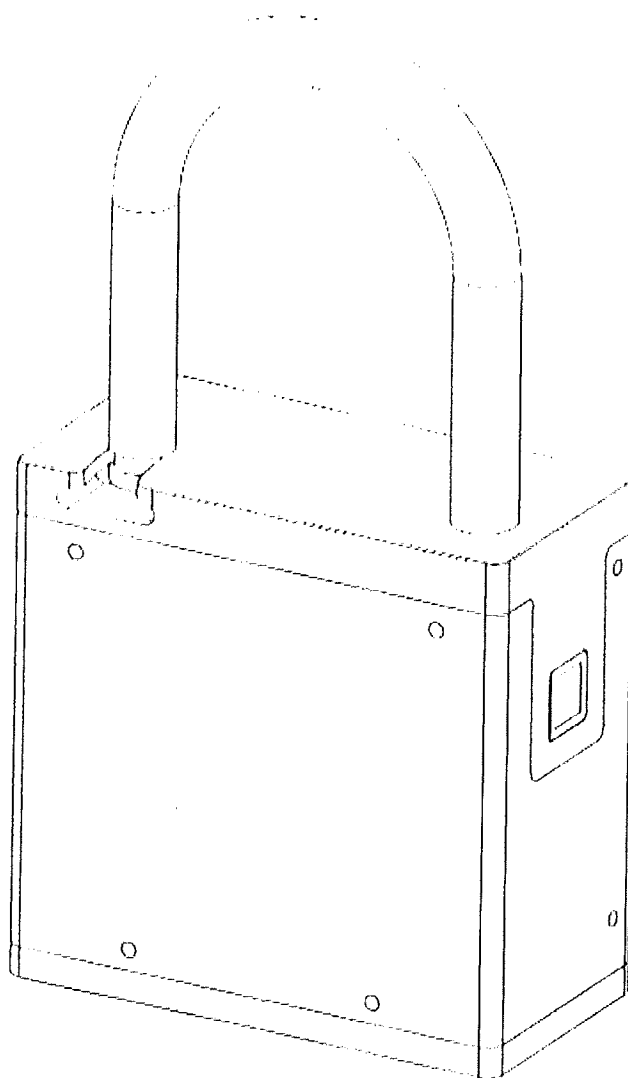

Fig. 1

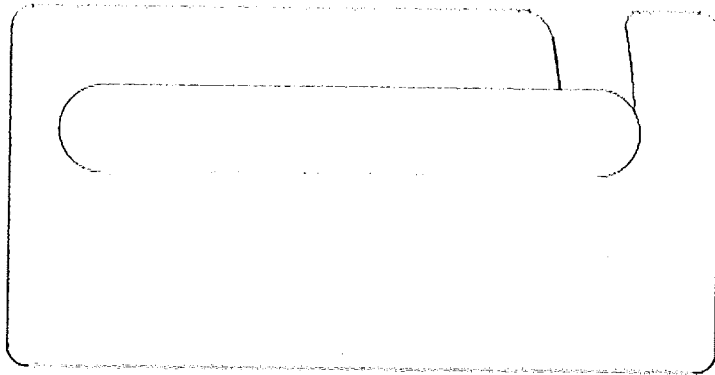

Fig. 2

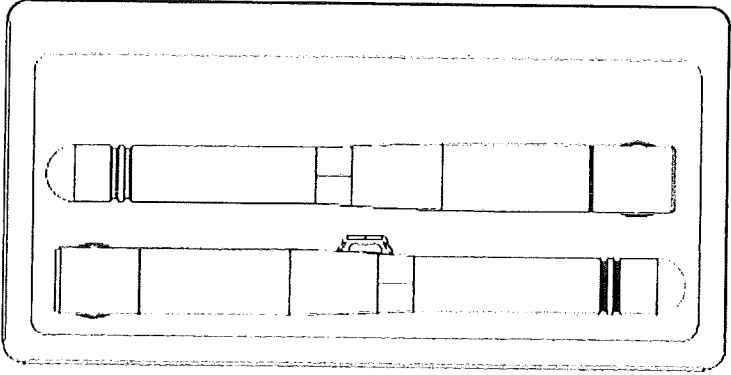

Fig. 3

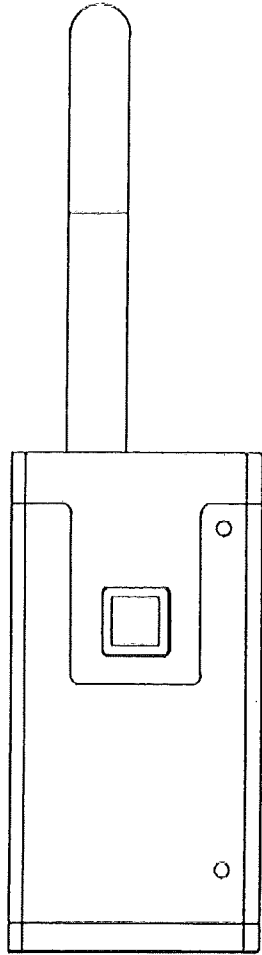

Fig. 4

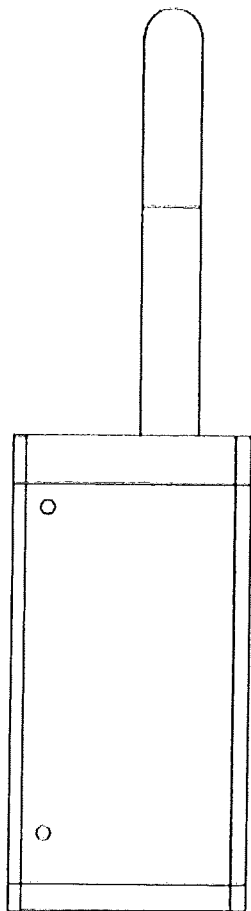

Fig. 5



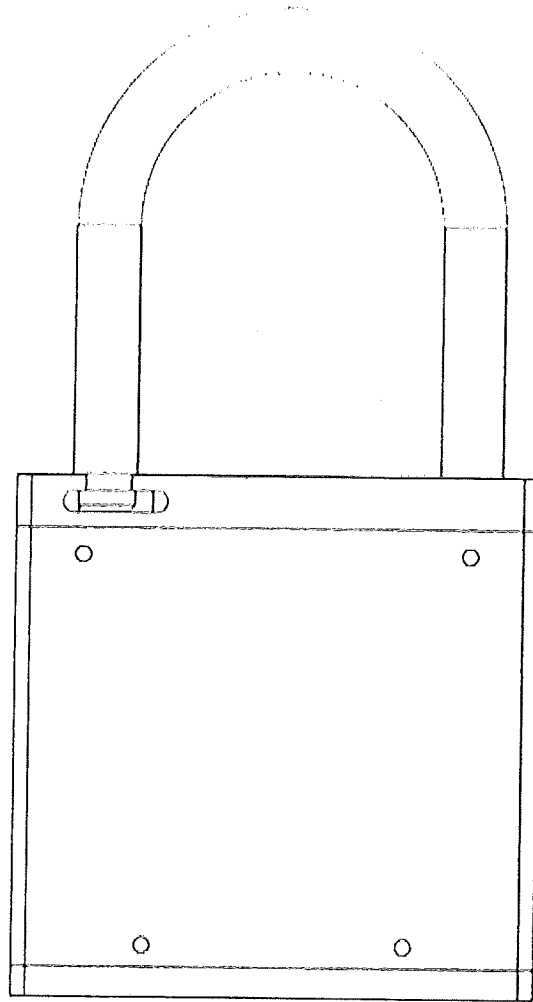

Fig. 6

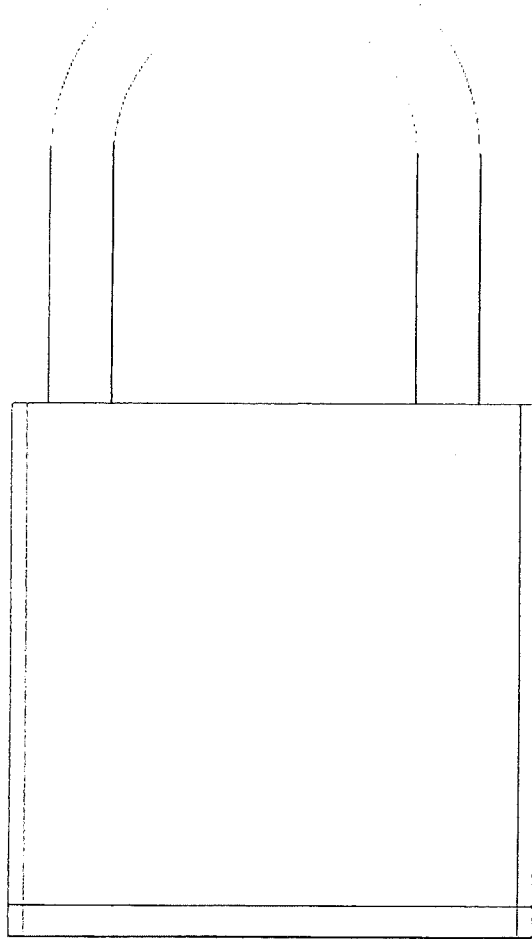

Fig. 7

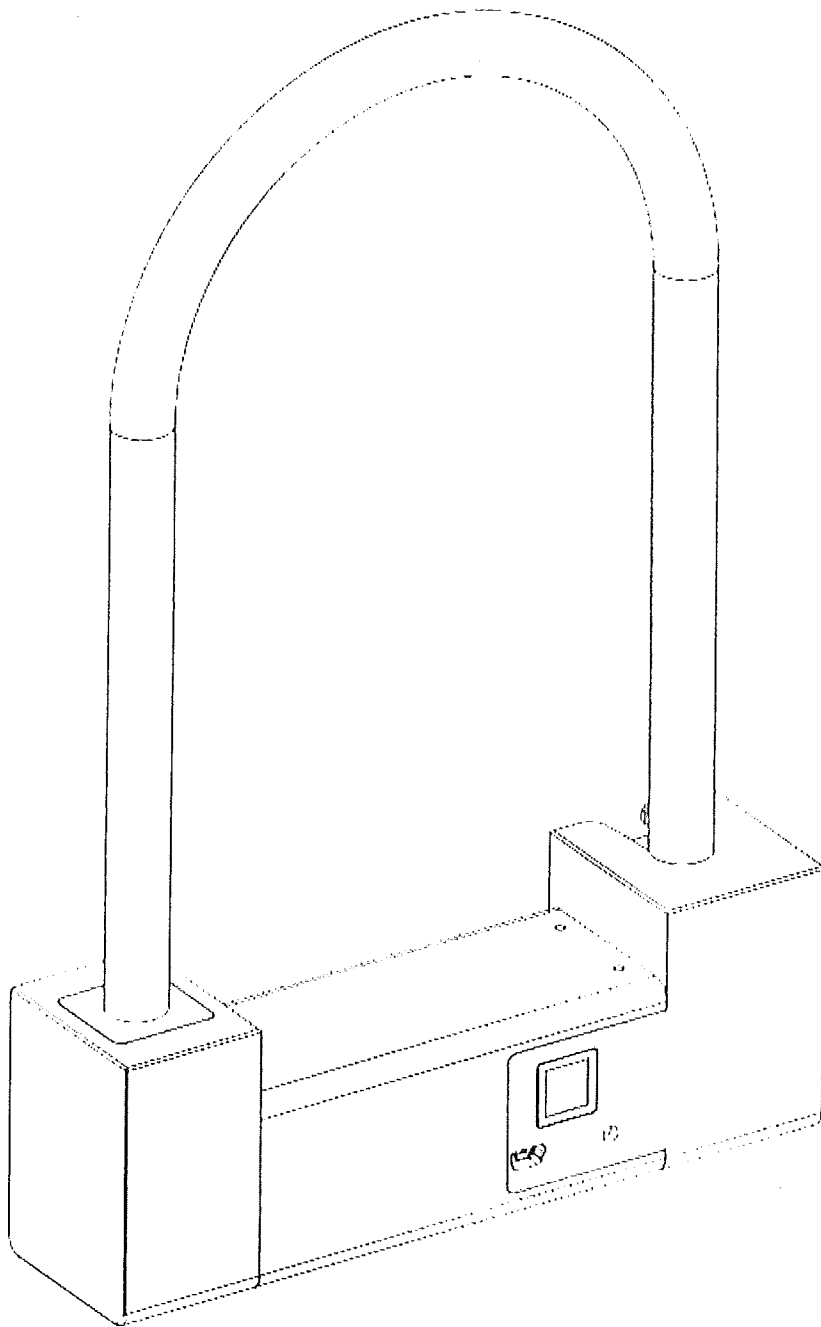

Fig. 1

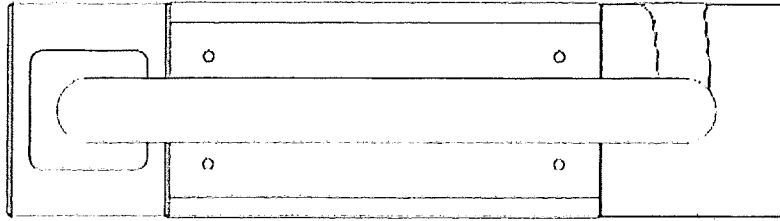

Fig. 2

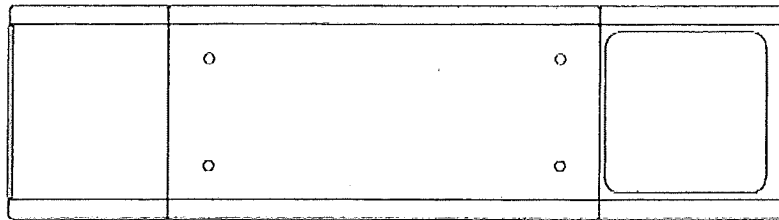

Fig. 3

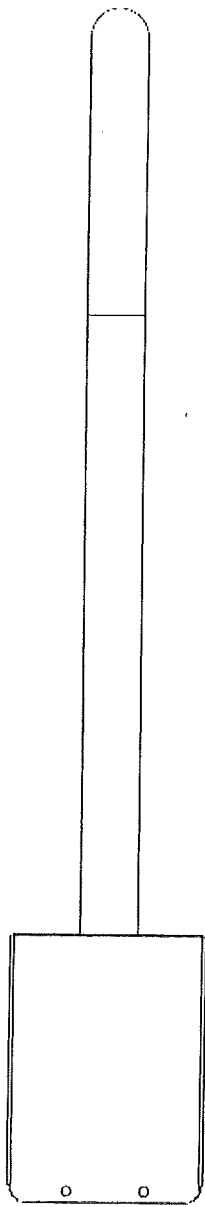

Fig. 4

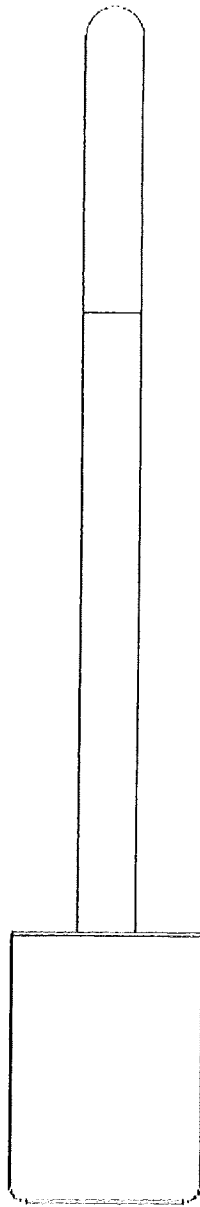

Fig. 5

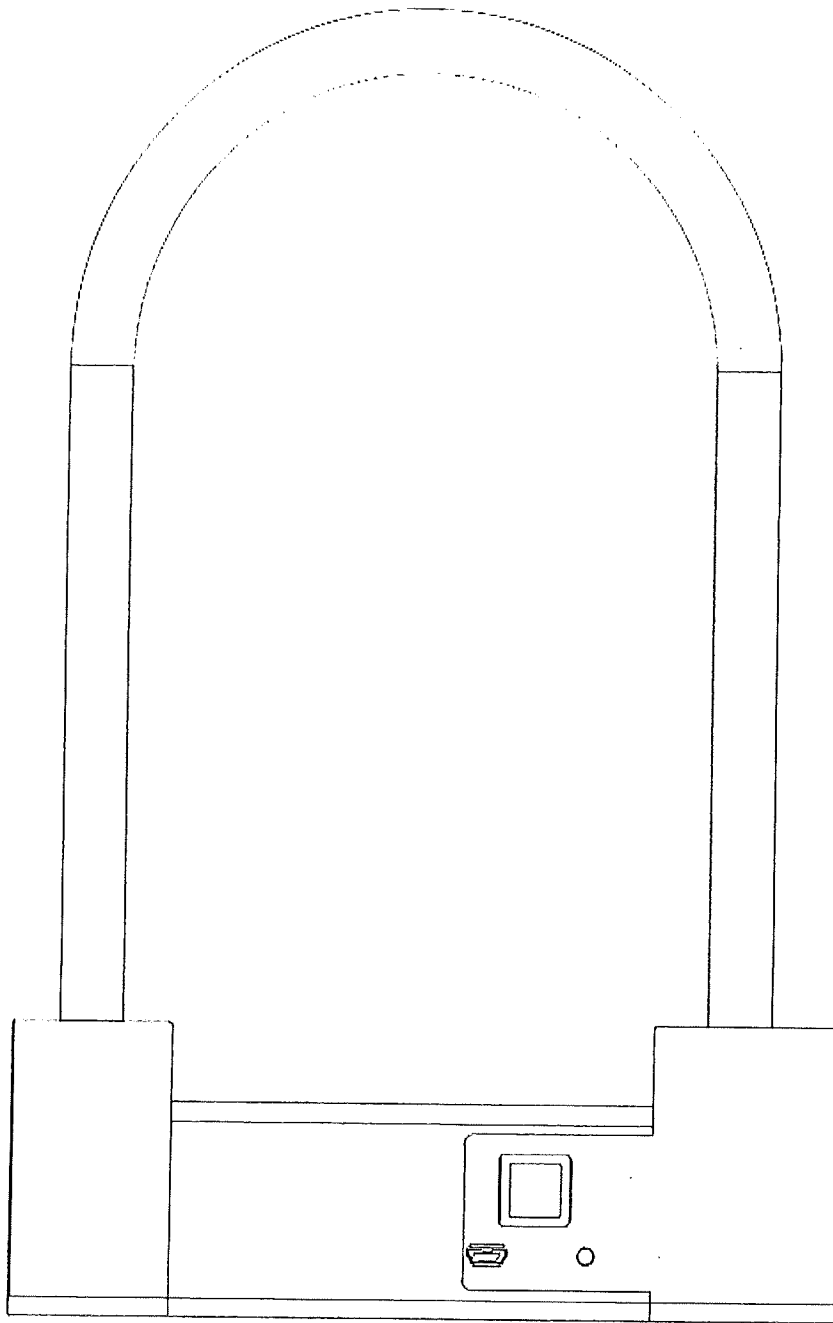

Fig. 6

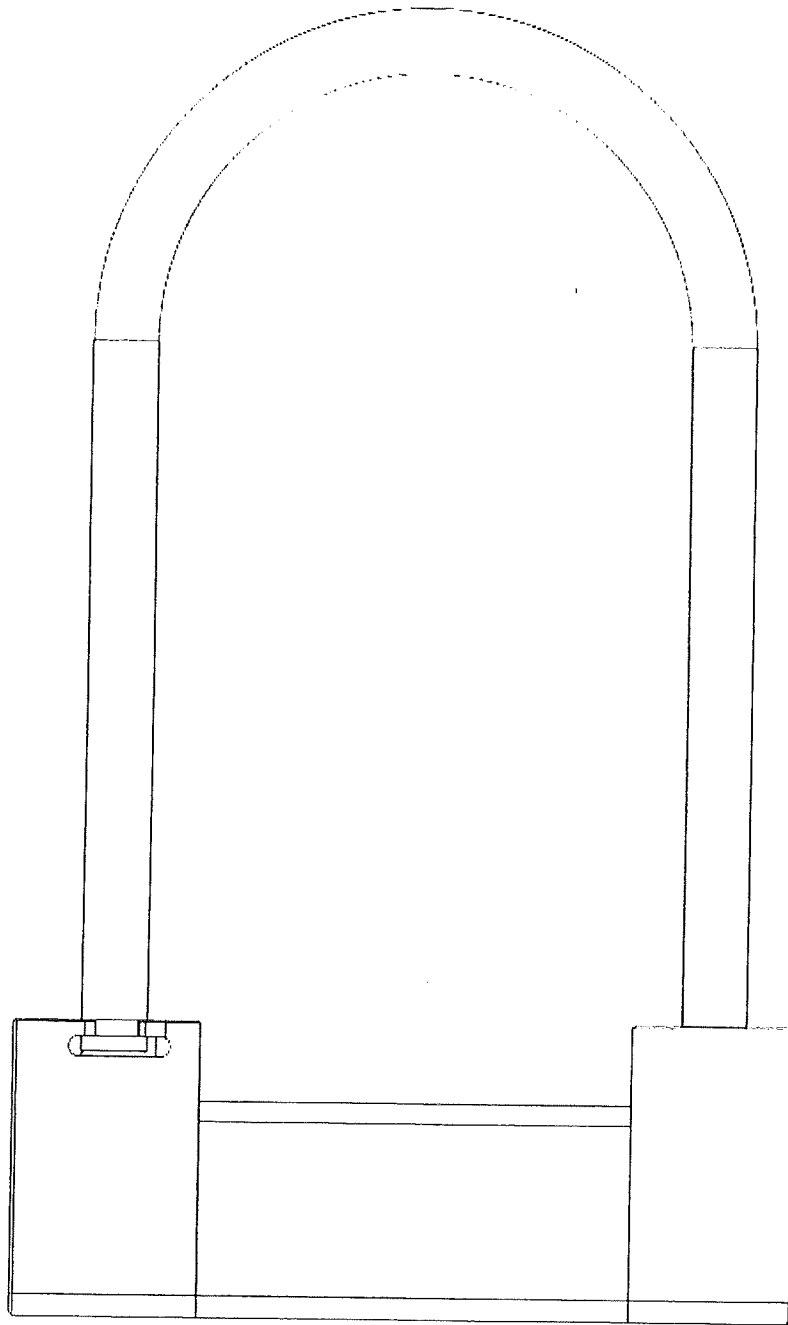

Fig. 7