

PATENT ASSIGNMENT COVER SHEET

Electronic Version v1.1
 Stylesheet Version v1.2

EPAS ID: PAT4628931

SUBMISSION TYPE:	NEW ASSIGNMENT
NATURE OF CONVEYANCE:	ASSIGNMENT
CONVEYING PARTY DATA	
Name	Execution Date
ROBERT T. WILLIAMS JR.	10/02/2017
MATTHEW D. WILDER	09/22/2017
CHRISTOPHER H. WILSON	09/22/2017
RECEIVING PARTY DATA	
Name:	THE MITCHELL GOLD CO.
Street Address:	135 ONE COMFORTABLE PLACE
City:	TAYLORSVILLE
State/Country:	NORTH CAROLINA
Postal Code:	28681
PROPERTY NUMBERS Total: 1	
Property Type	Number
Application Number:	29621147
CORRESPONDENCE DATA	
Fax Number:	(336)607-7500
<i>Correspondence will be sent to the e-mail address first; if that is unsuccessful, it will be sent using a fax number, if provided; if that is unsuccessful, it will be sent via US Mail.</i>	
Phone:	3366077347
Email:	dcooke@kilpatricktownsend.com
Correspondent Name:	N. DEAN POWELL, JR.
Address Line 1:	KILPATRICK TOWNSEND & STOCKTON LLP
Address Line 2:	1001 WEST FOURTH STREET
Address Line 4:	WINSTON-SALEM, NORTH CAROLINA 27101
ATTORNEY DOCKET NUMBER:	099039-1056375
NAME OF SUBMITTER:	DEBBIE K. COOKE
SIGNATURE:	/Debbie K. Cooke/
DATE SIGNED:	10/05/2017
Total Attachments: 21	
source=Assignment-1056375#page1.tif	
source=Assignment-1056375#page2.tif	
source=Assignment-1056375#page3.tif	

source=Assignment-1056375#page4.tif
source=Assignment-1056375#page5.tif
source=Assignment-1056375#page6.tif
source=Assignment-1056375#page7.tif
source=Assignment-1056375#page8.tif
source=Assignment-1056375#page9.tif
source=Assignment-1056375#page10.tif
source=Assignment-1056375#page11.tif
source=Assignment-1056375#page12.tif
source=Assignment-1056375#page13.tif
source=Assignment-1056375#page14.tif
source=Assignment-1056375#page15.tif
source=Assignment-1056375#page16.tif
source=Assignment-1056375#page17.tif
source=Assignment-1056375#page18.tif
source=Assignment-1056375#page19.tif
source=Assignment-1056375#page20.tif
source=Assignment-1056375#page21.tif

ASSIGNMENT OF PATENT APPLICATION

For good and valuable consideration, the receipt and sufficiency of which are hereby acknowledged, we, the undersigned Inventors/Assignors:

Robert T. Williams, Jr., 135 One Comfortable Place, Taylorsville, NC 28681
Matthew D. Wilder, 135 One Comfortable Place, Taylorsville, NC 28681
Christopher H. Wilson, 135 One Comfortable Place, Taylorsville, NC 28681

(collectively "the Inventors" or "the Assignors") do hereby acknowledge and agree that they were each hired to invent all of their designs, inventions, creations, and all other works (including, among all others, the design(s)/invention(s)/work(s) that are the subjects of this Assignment) (collectively the "Inventions") created and/or performed by, during, through, in connection with, as part of, and/or within the scope of each Assignor's employment with The Mitchell Gold Co., a North Carolina corporation, having a principal place of business located at 135 One Comfortable Place, Taylorsville, NC 28681 ("the Assignee"), and that all such Inventions are considered "works for hire", and the Assignors intended for The Mitchell Gold Co. to own all shop rights and all other rights, title, and interest in and to all Inventions from the date of creation of all Inventions. Thus, this Assignment formalizes in writing the circumstances that are already understood, acknowledged, and agreed by Assignors to exist concerning The Mitchell Gold Co.'s ownership of Inventions and is also made for the purposes of accompanying the documentation that is anticipated to be filed with the United States Patent and Trademark Office. If, for any reason, the Inventions would not be included in the hired to invent/shop rights/works for hire legal doctrines or principles as a matter of law, and/or if it is deemed necessary to fully vest the Assignee with ownership and legal title to any and/or all Inventions, Assignors do hereby irrevocably sell, assign, and transfer to the Assignee and to the Assignee's successors and assigns, all rights, title, and interest in the Inventions for all countries including, but not limited to, the United States, and including for the patent application entitled:

SOFA

and which is found in the U.S. Design Patent Application attached herewith, and in and to any and all inventions disclosed in the Application ("the Invention") and all nonprovisional applications for United States Patent, including divisional, continuing, substitute, renewal, and reissue thereof, and all other applications for United States Letters Patent or other related property rights in any and all foreign countries which have been or shall be filed on the Invention or on one or more of the Inventions, and in and to all original and reissued patents or related foreign documents that have been or shall be issued on one or more of the Inventions.

We, the Assignors, in accordance with this Assignment, authorize and request the Commissioner for Patents of the United States to issue to the Assignee or the Assignee's successors and assigns, in accordance with this Assignment, any and all United States Letters Patents that claim or disclose one or more of the Inventions.

We, the Assignors, further agree, for good and valuable consideration, the receipt of which is hereby acknowledged, that the Assignee or the Assignee's successors and assigns may apply for and receive foreign Letters Patents or similar such rights and, in doing so, may make a claim of priority to the Application under the provisions of any bilateral or multilateral treaty or international agreement, including but not limited to, the International Convention of 1883 and later modifications thereof ("the Paris Convention"), the Patent Cooperation Treaty, the European Patent Convention, the Eurasian Patent Convention, the agreement(s) of the African Regional Intellectual Property Organization, the agreement(s) of the Organisation Africaine de la Propriété Intellectuelle, and the agreement(s) of the Cooperation Council

for the Arab States of the Gulf; and that, when requested, without charge to the Assignee and/or to the Assignee's successors and assigns, to carry out in good faith the intent and purpose of this Assignment, the Inventors, or their executors or administrators, will, for the United States and any and all foreign countries: (i) execute any and all documents related to any application for patent in the United States or a foreign country, where such application discloses one or more of the Inventions; (ii) execute any and all oaths, declarations, assignments, confirmatory assignments, powers of attorney, and other papers concerning one or more of the Inventions and any and all patent applications thereon, whether in the United States or a foreign country; and (iii) perform other such acts, at the request of the Assignee or the Assignee's successors and assigns, to obtain or maintain any and all patents and/or related property rights in the United States or any foreign country on one or more of the Inventions or any improvements thereto and to vest title thereto in the Assignee and/or the Assignee's successors and assigns.

Further, we, the Assignors, agree that, without charge to the Assignee and/or the Assignee's successors and assigns, will communicate to said Assignee and/or to Assignee's representatives any facts known to any of us respecting said Inventions, will testify in any legal proceeding, will execute all divisional, continuation, substitute, renewal, and reissue applications, and will do everything possible to aid said Assignee, and its successors and assigns, to obtain and enforce proper protection for the Inventions in the United States and its territorial possessions and in any and all foreign countries.

The undersigned Assignors/Inventors hereby grant the firm of Kilpatrick Townsend & Stockton LLP of 1001 West Fourth Street, Winston-Salem, North Carolina 27101-2400 the power to insert onto (or on or about) this Assignment any further identification, including the application number, application serial number, registration number, and/or filing date, which may be necessary or desirable in order to comply with the rules of the United States Patent and Trademark Office for recordation of this document.

In testimony whereof, we, the Assignors/Inventors, have signed our names below on the date indicated. By such signature, we, the Assignors, acknowledge that we are of sound mind and health, are of the age of majority, that we have read and understood all terms recited above, and that we are signing this of our own free will and volition for the purposes stated herein and for all related purposes.

SIGNATURES ARE ON THE FOLLOWING PAGES

(Remainder of page intentionally left blank)

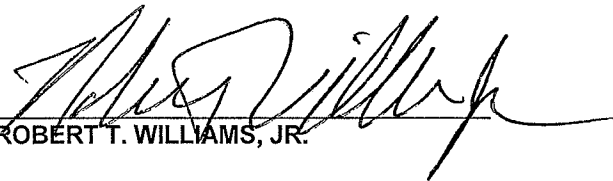
ROBERT T. WILLIAMS, JR.

10.2.17
Date

State of North Carolina
County of Alexander

Before me, on ~~September~~ October 2, 2017, personally appeared ROBERT T. WILLIAMS, JR., who is known to me to be the individual described above and who I witnessed execute the foregoing Assignment.

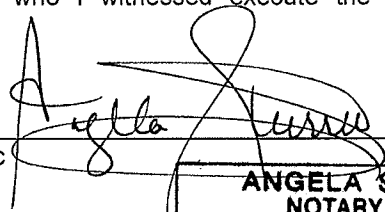
Notary Public

My Commission Expires:

ANGELA SHERRILL
NOTARY PUBLIC
Catawba County
North Carolina
My Commission Expires July 28, 2020



MATTHEW D. WILDER

09.22.17

Date

State of North Carolina

County of Alexander

Before me, on September 22, 2017, personally appeared MATTHEW D. WILDER, who is known to me to be the individual described above and who I witnessed execute the foregoing Assignment.

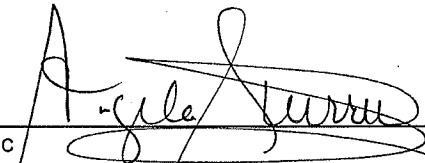

Notary Public

My Commission Expires:

**ANGELA SHERRILL
NOTARY PUBLIC
Catawba County
North Carolina
My Commission Expires July 28, 2020**

Christopher H. Wilson
CHRISTOPHER H. WILSON

9-22-17
Date

State of North Carolina

County of Alexander

Before me, on September 22, 2017, personally appeared CHRISTOPHER H. WILSON, who is known to me to be the individual described above and who I witnessed execute the foregoing Assignment.

Angela Sherrill
Notary Public

My Commission Expires:

ANGELA SHERRILL NOTARY PUBLIC Catawba County North Carolina My Commission Expires July 28, 2020
--

APPLICATION FOR UNITED STATES DESIGN LETTERS PATENT

To All Whom It May Concern:

BE IT KNOWN THAT Robert T. Williams, Jr., a citizen of the United States of America and a resident of the city of Hickory, NC, Matthew D. Wilder, a citizen of the United States of America and a resident of the city of Hickory, NC, and Christopher H. Wilson, a citizen of the United States of America and a resident of the city of Statesville, NC, have invented a new and ornamental design for sofa, for which the following is the specification, reference being made to the accompanying drawings forming a part thereof.

SOFA

IN THE DRAWINGS

A description of the drawings is as follows:

FIG. 1 is a top, perspective view of a sofa comprising the present invention.

FIG. 2 is a front elevational view of the sofa shown in FIG. 1.

FIG. 3 is a side elevational view of the sofa shown in FIGS. 1 and 2.

FIG. 4 is a side elevational view of the sofa shown in FIGS. 1, 2, and 3.

FIG. 5 is a rear elevational view of the sofa shown in FIGS. 1, 2, 3, and 4.

FIG. 6 is a top plan view of the sofa shown in FIGS. 1, 2, 3, 4, and 5.

FIG. 7 is a bottom plan view of the sofa shown in FIGS. 1, 2, 3, 4, 5, and 6.

FIG. 8 is a perspective view of another embodiment of sofa comprising the present invention.

FIG. 9 is a front elevational view of the sofa shown in FIG. 8.

FIG. 10 is a side elevational view of the sofa shown in FIGS. 8 and 9.

FIG. 11 is a side elevational view of the sofa shown in FIGS. 8, 9, and 10.

FIG. 12 is a rear elevational view of the sofa shown in FIGS. 8, 9, 10, and 11.

FIG. 13 is a top plan view of the sofa shown in FIGS. 8, 9, 10, 11, and 12.

FIG. 14 is a bottom plan elevational view of the sofa shown in FIGS. 8, 9, 10, 11, 12, and 13.

The broken lines are for environmental purposes only and form no part of the claimed design.

CLAIM

We claim the ornamental design for the sofa as shown and described.

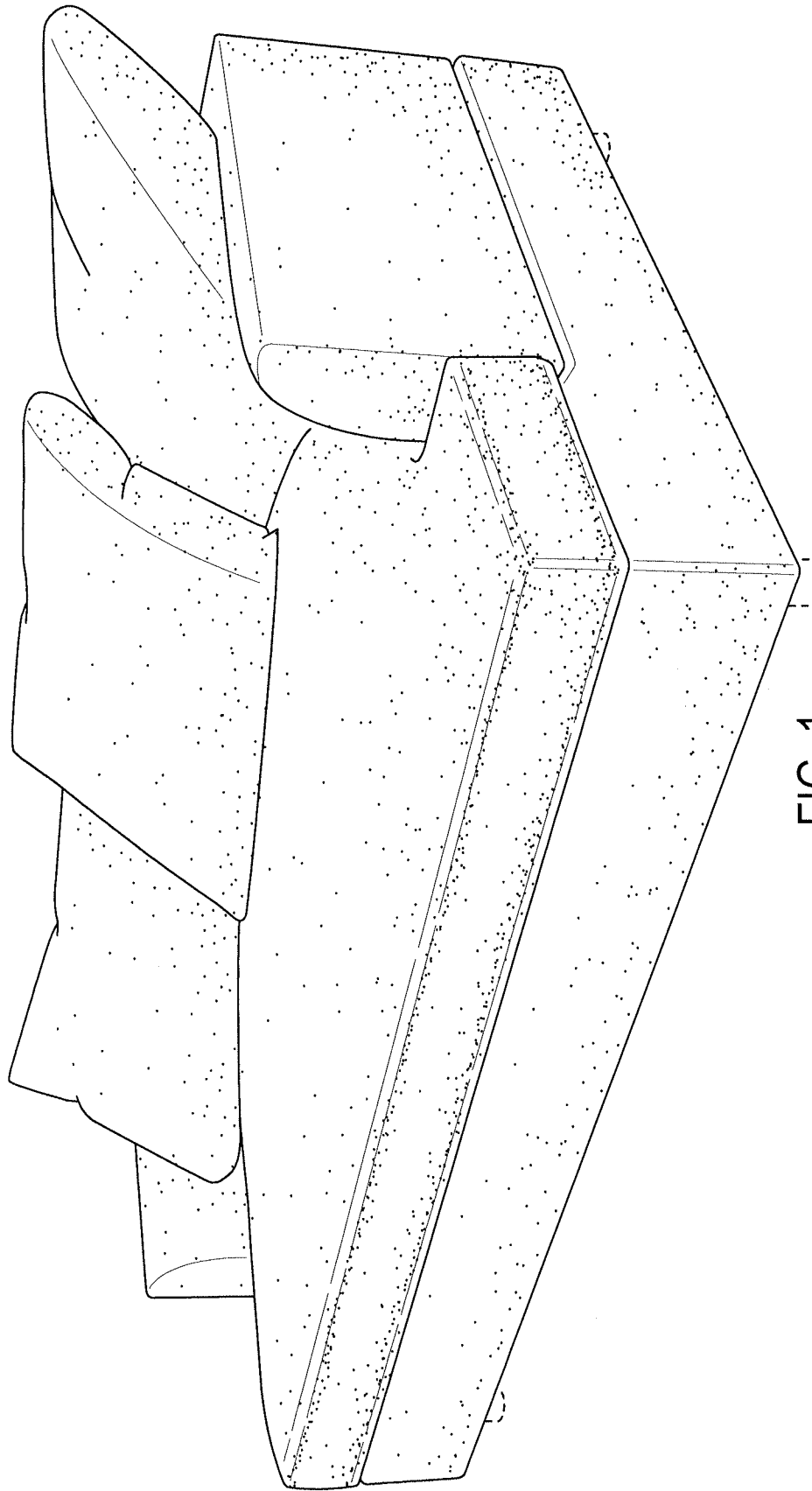

FIG. 1

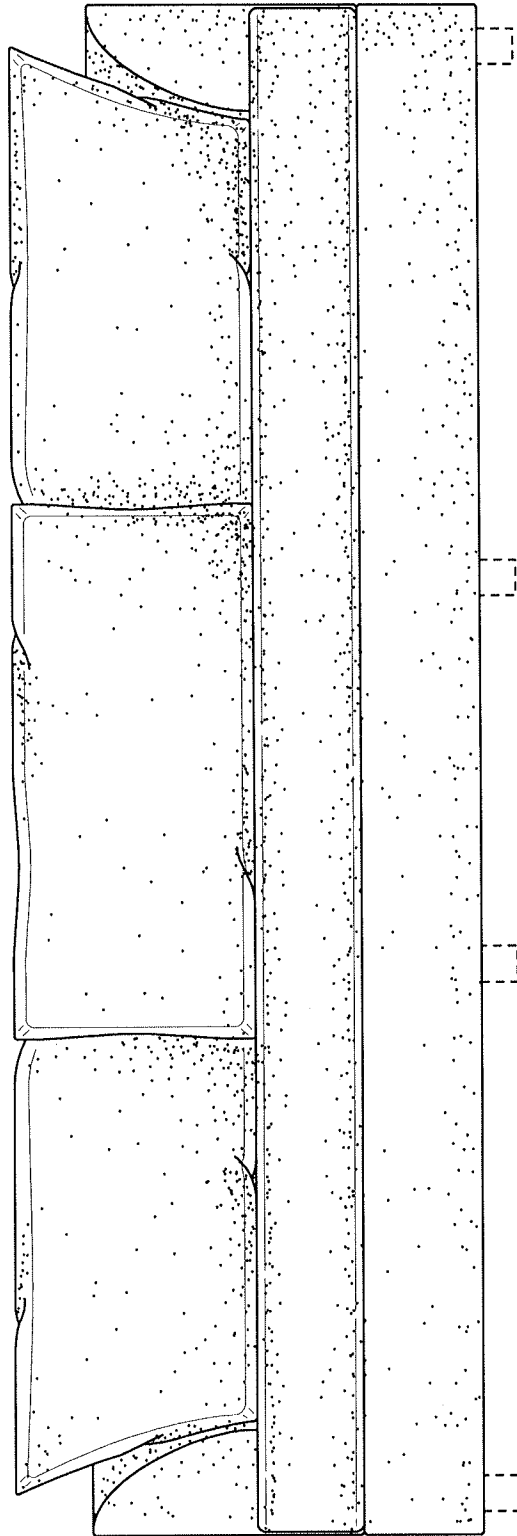

FIG. 2

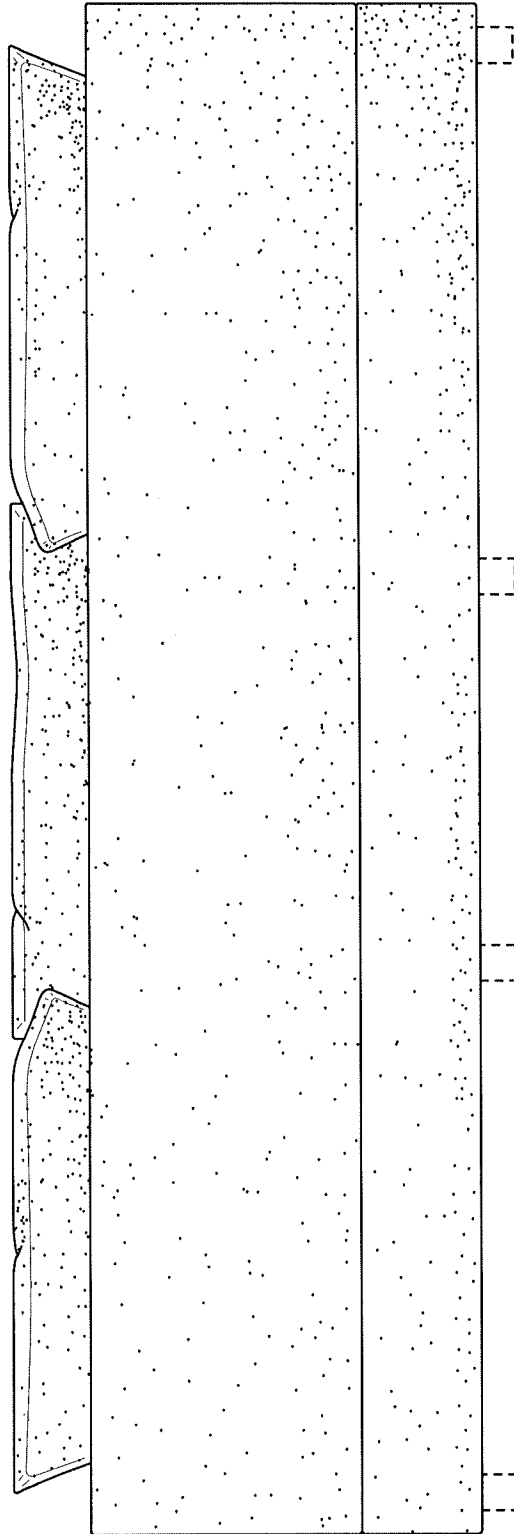

FIG. 3

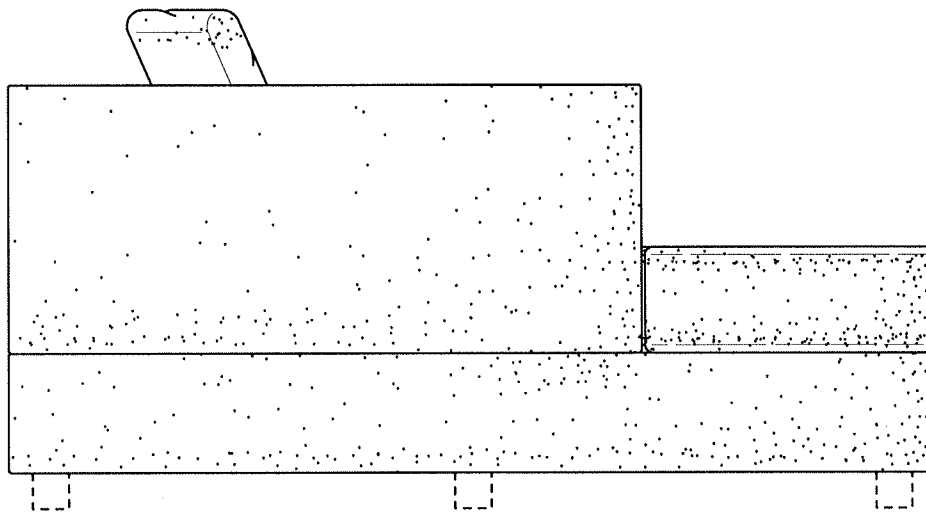

FIG. 4

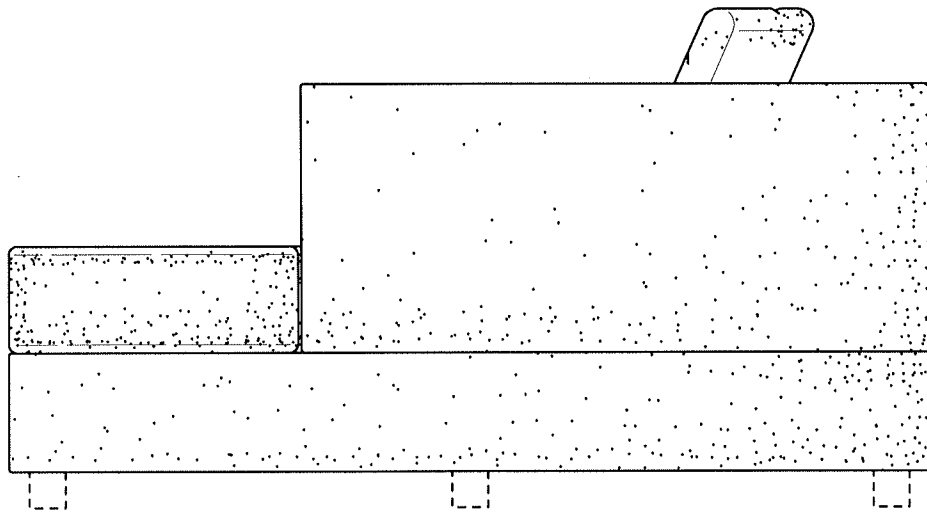

FIG. 5

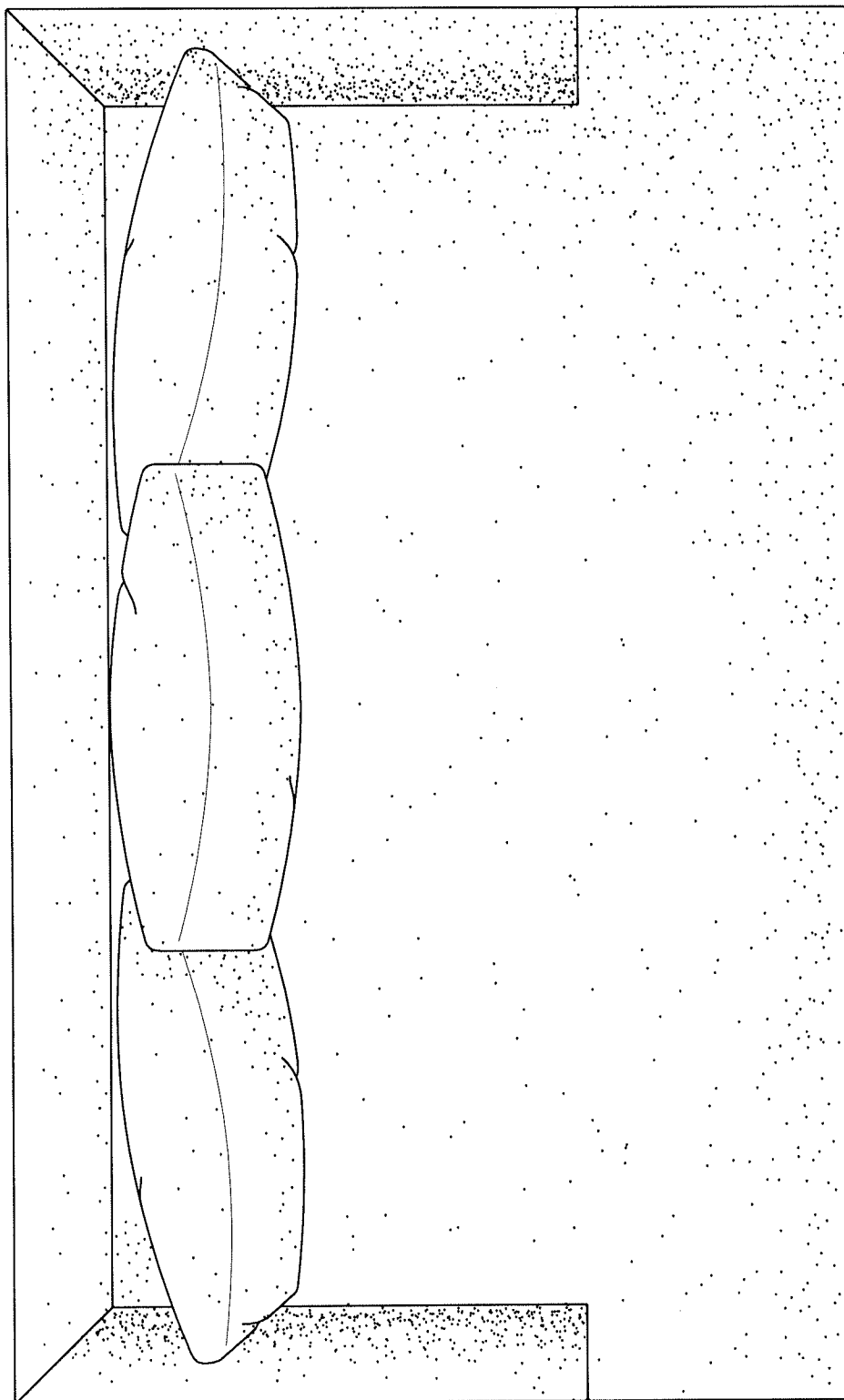

FIG. 6

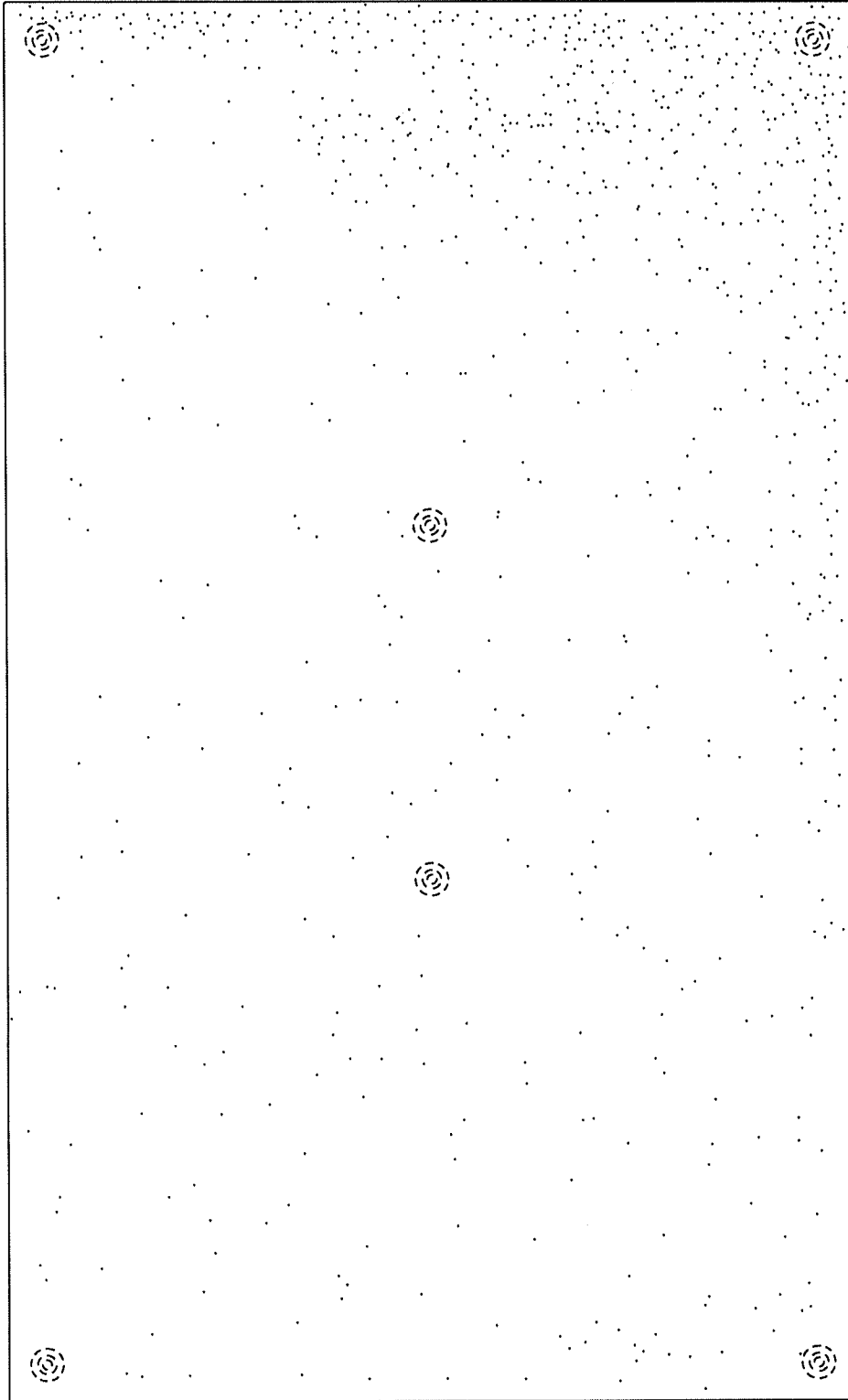

FIG. 7

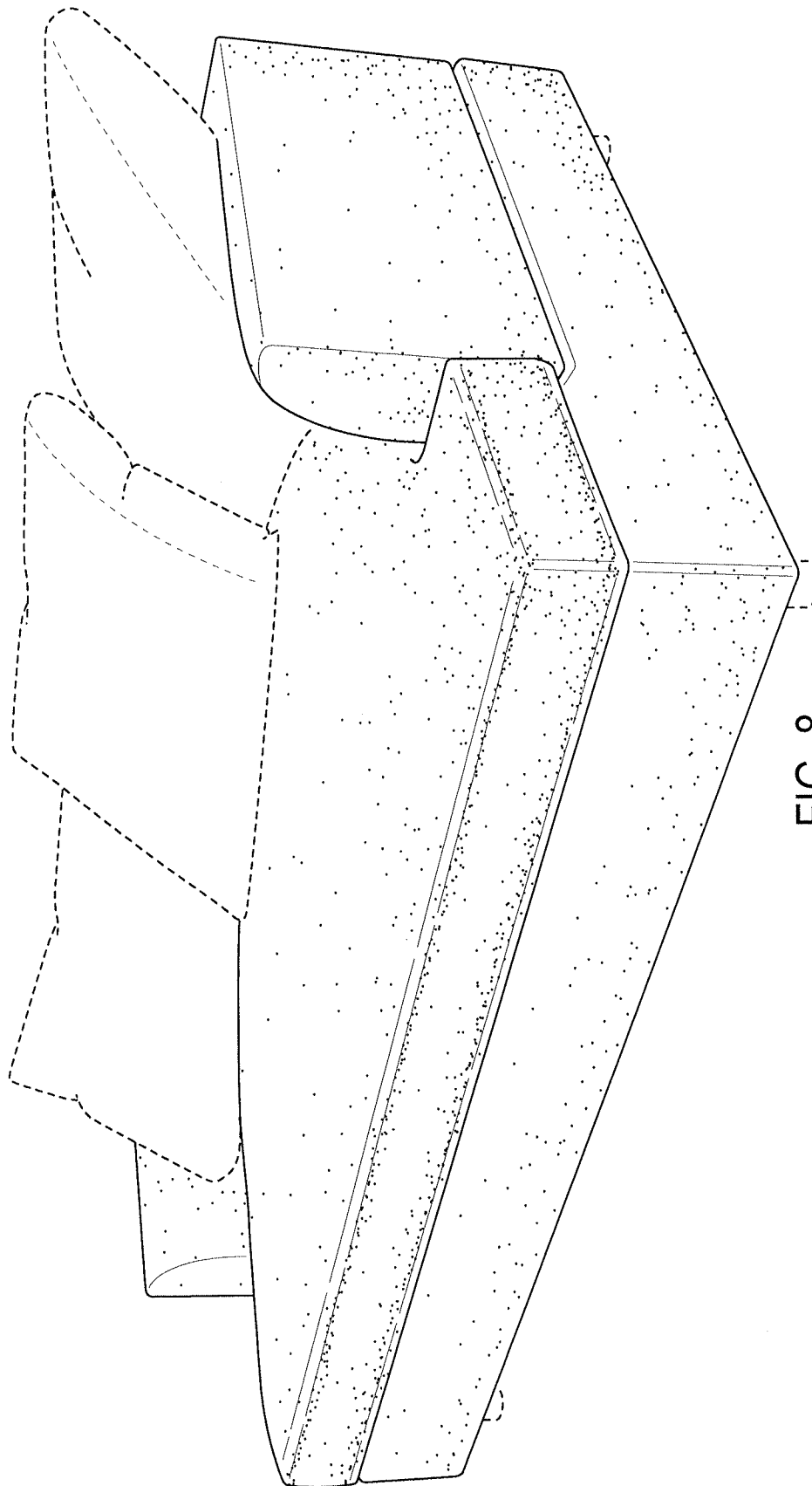

FIG. 8

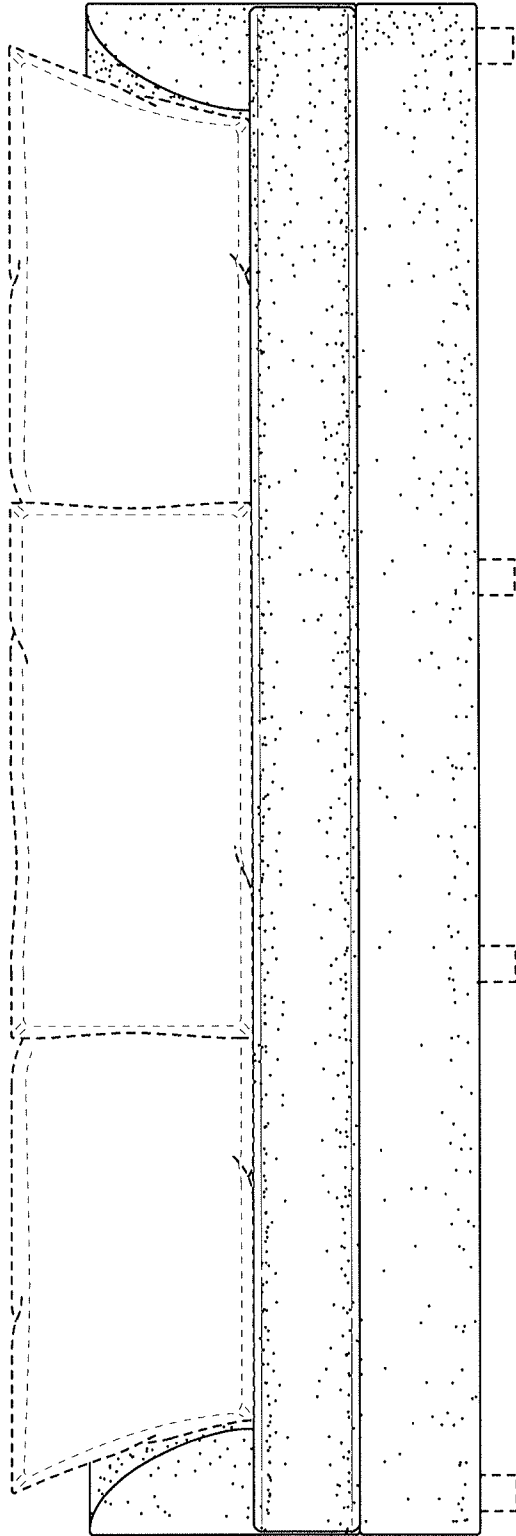

FIG. 9

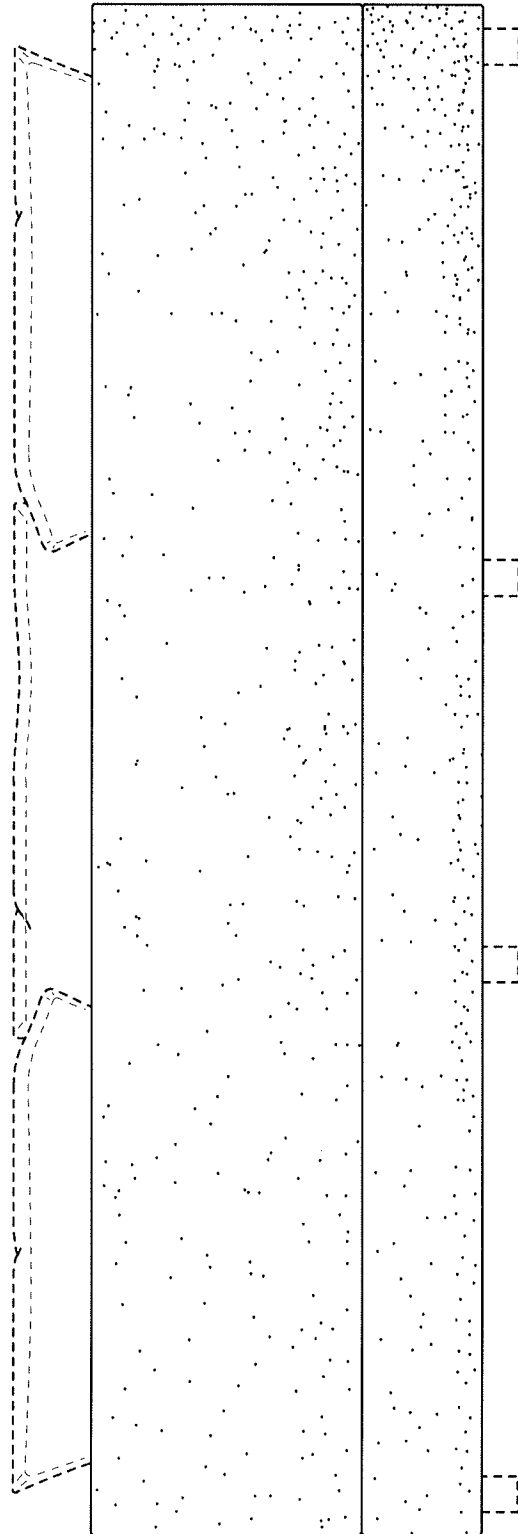

FIG. 10

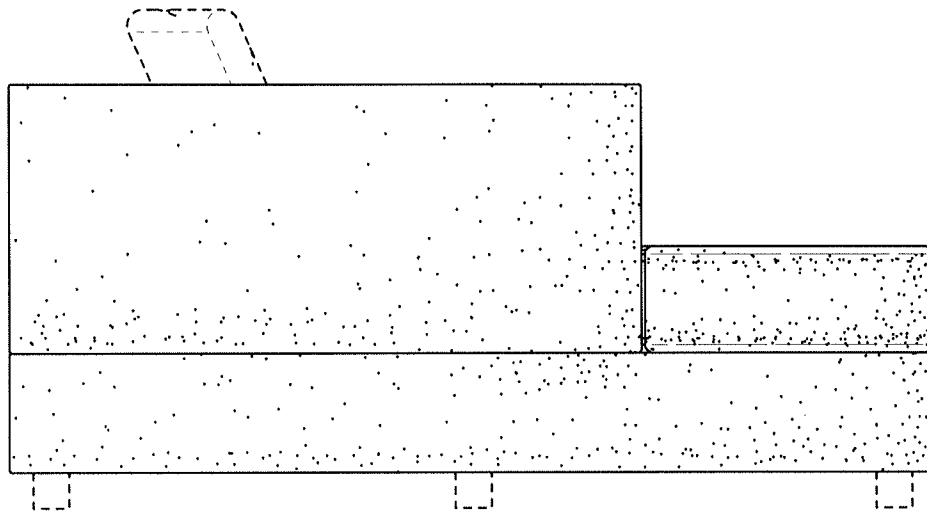

FIG. 11

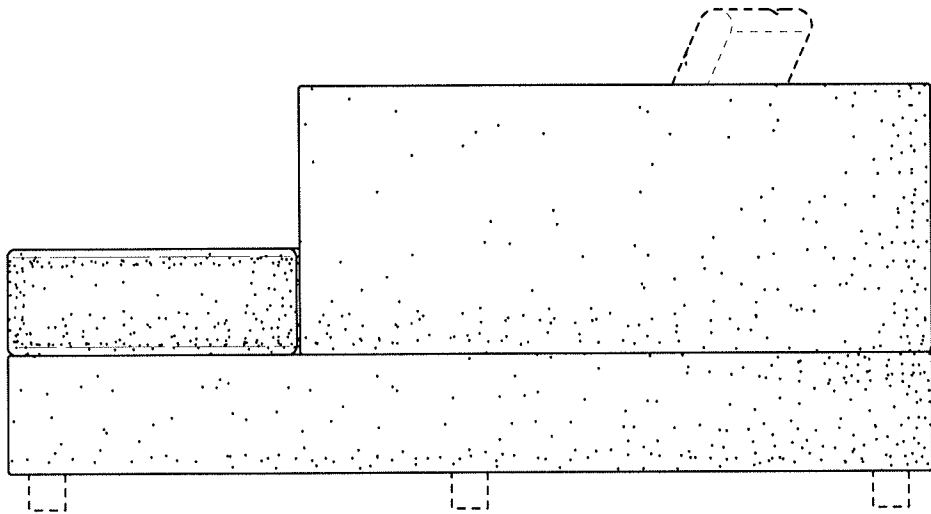

FIG. 12

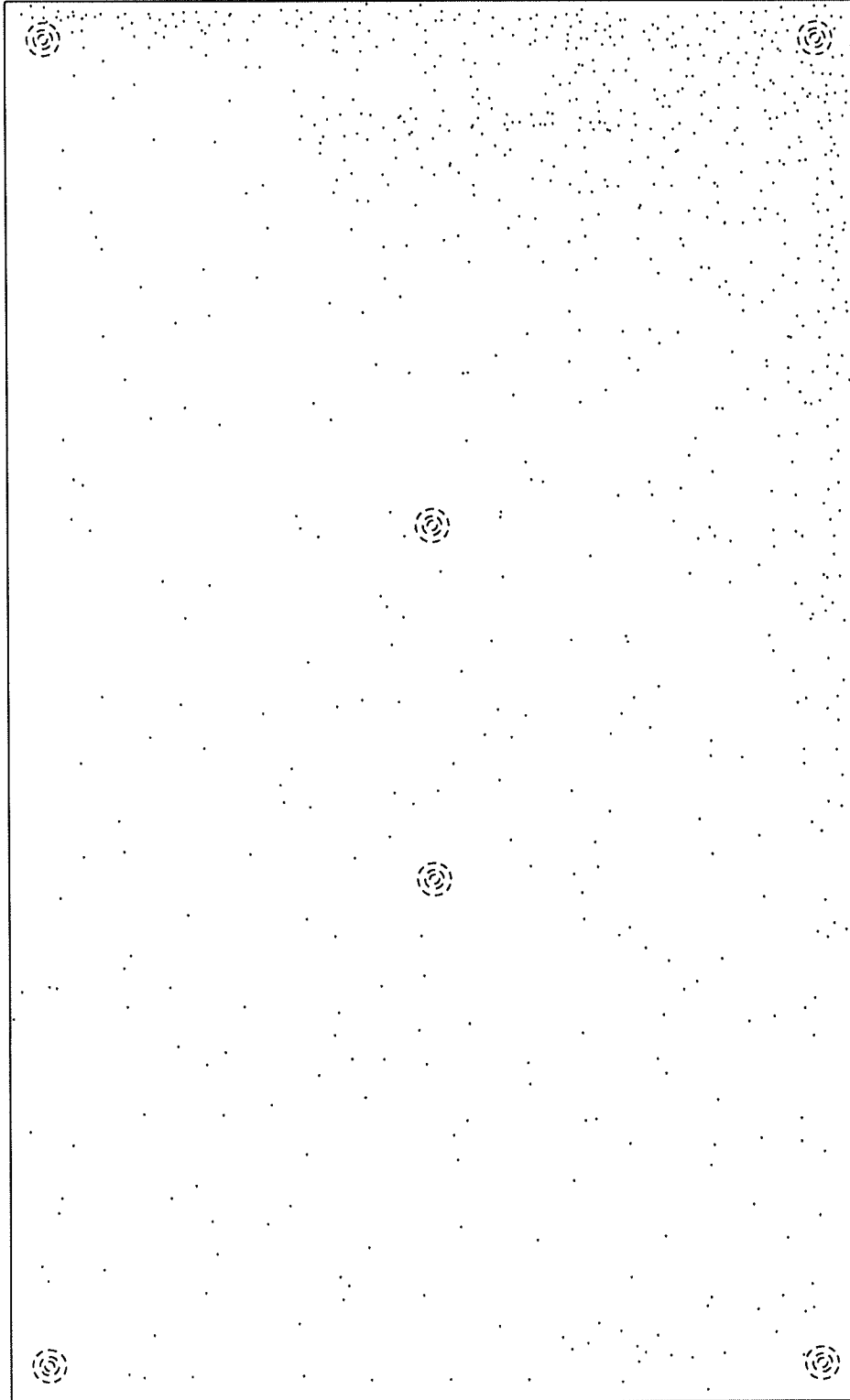

FIG. 14