

PATENT ASSIGNMENT COVER SHEET

Electronic Version v1.1
Stylesheet Version v1.2

EPAS ID: PAT5982894

SUBMISSION TYPE:	NEW ASSIGNMENT
NATURE OF CONVEYANCE:	ASSIGNMENT
CONVEYING PARTY DATA	
Name	Execution Date
HAYDEN WADSWORTH	02/24/2020
RECEIVING PARTY DATA	
Name:	HYDROJUG, LLC
Street Address:	2675 INDUSTRIAL DRIVE, SUITE 203
City:	OGDEN
State/Country:	UTAH
Postal Code:	84401
PROPERTY NUMBERS Total: 1	
Property Type	Number
Application Number:	29725582
CORRESPONDENCE DATA	
Fax Number:	
<i>Correspondence will be sent to the e-mail address first; if that is unsuccessful, it will be sent using a fax number, if provided; if that is unsuccessful, it will be sent via US Mail.</i>	
Phone:	435-512-4893
Email:	preston@projectcip.com
Correspondent Name:	PRESTON P. FRISCHKNECHT LAW OFFICE OF PR
Address Line 1:	408 SHERIDAN RIDGE LANE
Address Line 4:	NIBLEY, UTAH 84321
ATTORNEY DOCKET NUMBER:	HYDCIP024
NAME OF SUBMITTER:	PRESTON P. FRISCHKNECHT
SIGNATURE:	/Preston P. Frischknecht/
DATE SIGNED:	02/26/2020
Total Attachments: 10	
source=assignmentEX022620x#page1.tif	
source=assignmentEX022620x#page2.tif	
source=assignmentEX022620x#page3.tif	
source=assignmentEX022620x#page4.tif	
source=assignmentEX022620x#page5.tif	
source=assignmentEX022620x#page6.tif	

source=assignmentEX022620x#page7.tif
source=assignmentEX022620x#page8.tif
source=assignmentEX022620x#page9.tif
source=assignmentEX022620x#page10.tif

INVENTION ASSIGNMENT

WHEREAS, Hayden Wadsworth, Ogden, UT (“Assignor”) is inventor of a **CONTAINER** (“the Invention”), a copy or copy portion of which is attached hereto as “Exhibit A”, and

WHEREAS, Assignor believes himself to be the original, first, and/or sole inventor of the Invention disclosed and claimed in Exhibit A; and

WHEREAS, HYDROJUG, LLC, 2675 Industrial Drive, Suite 203, Ogden, UT 84401 (“Assignee”) desires to acquire by formal, recordable assignment any right, title, and interest in and to said Invention, and said Patent Application in the United States and throughout the world;

NOW, THEREFORE, in consideration of good and valuable consideration rendered by Assignee:

1. Assignment. Assignor hereby grants and assigns unto Assignee, any right, title, and interest in the invention, including any and all patent applications based upon it. Assignee also hereby acquires the right, power, and authority to file and prosecute any patent application in its own name. Assignee also maintains the right to bring actions for infringement related to the invention in its own name, specifically including the right to seek damages for any past infringement.

2. General authorization. Assignor authorizes and requests the Commissioner of Patents and Trademarks of the United States and of all foreign countries to issue any Patent granted for said Invention, whether on an application for said Invention, said Patent Application, or on any subsequently filed provisional, non-provisional, divisional, continuation, continuation-in-part, reissue, or other application, to Assignee, its successors and assigns, as the assignee of their entire interest in said Invention.

3. Representations and warranties. Assignor individually represents and warrants as follows:

- (a) he is Assignee’s employee or the sole owner of the Invention;
- (b) he has not sold or transferred the Invention to any third party;
- (c) he has the authority to enter into this agreement;
- (d) he does not believe that the Invention has been taken from any third party without authorization (e.g., a knowing copy of another company’s invention);
- (e) he does not know of any permissions that have to be obtained in order for this assignment to be completed;
- (f) the Invention was not conceived or created in the course and conduct of Assignor’s employment by a separate, third party.

4. Agreement to cooperate. Assignor hereby agrees, without further consideration and without expense to Assignee, to sign all lawful papers and to perform all other lawful acts which the Assignee may request in order to make this Assignment fully effective, including the furnishing of all lawful documents as requested by Assignee to further the prosecution of any patent applications relating to the invention, cooperation to the best of Assignor’s ability in executing all other lawful documents pertaining

to the invention, and producing evidence in any actions or proceedings concerning the invention, including, but not limited to, nullification, reissuance, extension, and infringement proceedings.

5. Forum selection. The Parties agree that any action or lawsuit arising out of or related to this Agreement—including but not limited to any action brought to enforce the terms of this Agreement—shall be brought in the federal or state courts of the State of Utah. The Parties agree that they are subject to the personal jurisdiction of such courts for the purposes of any such lawsuit or action.

6. Prevailing party costs and attorneys' fees. In any action arising out of this Agreement, including but not limited to any action brought to enforce the terms of this Agreement, the prevailing Party shall be entitled to the recovery of reasonable attorneys' fees and reasonably incurred costs and expenses of litigation.

This assignment and agreement shall be binding upon any and all heirs and legal representatives of Assignor.

ASSIGNOR HAYDEN WADSWORTH

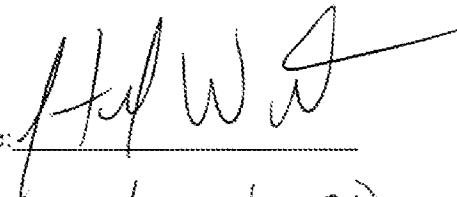
Signature: 

Date: 2/24/2020

SEND COPY TO:

Mail Stop Assignment Recording Services
Director of the United States Patent and Trademark Office
P.O. Box 1450
Alexandria, VA 22313-1450

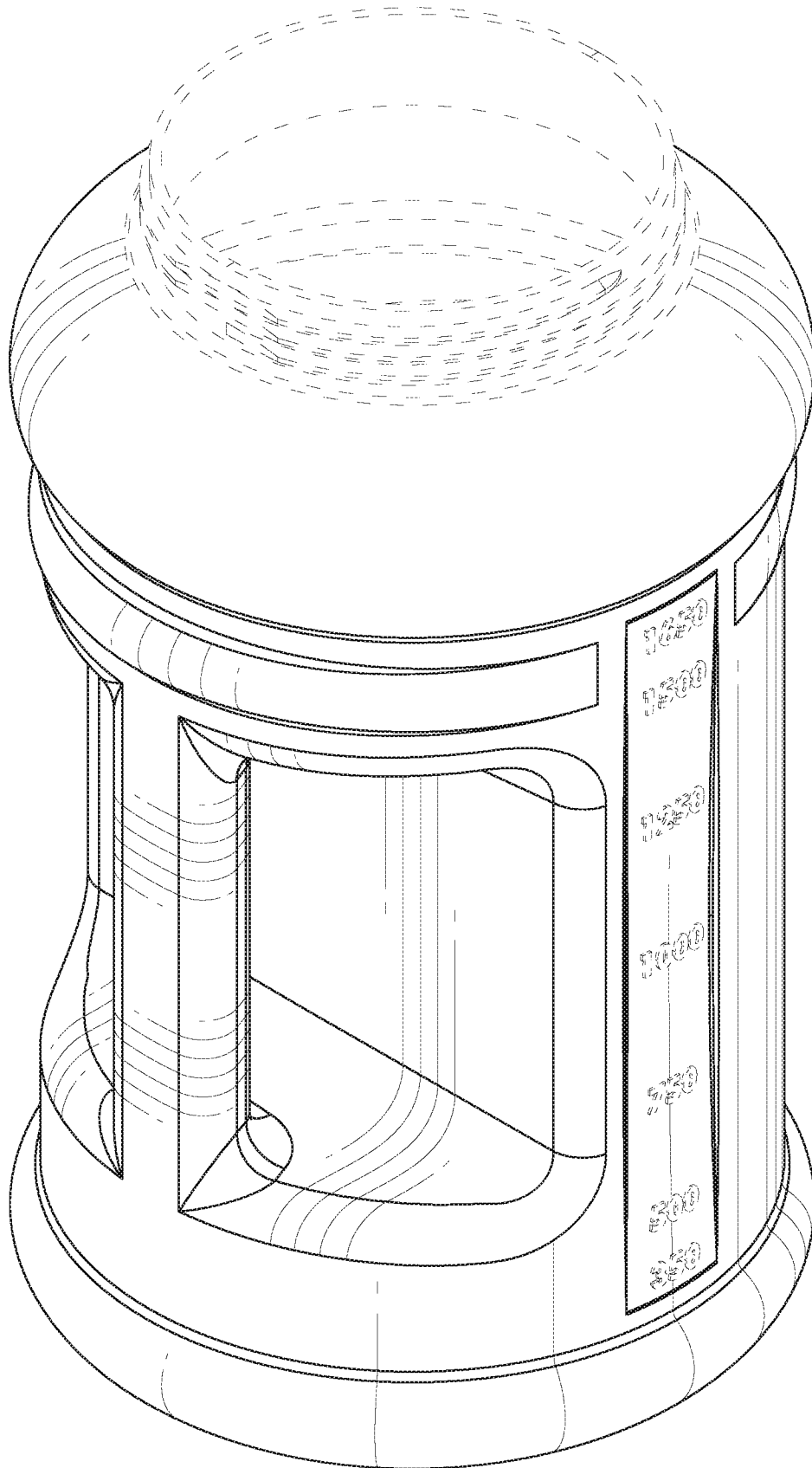

FIG. 1

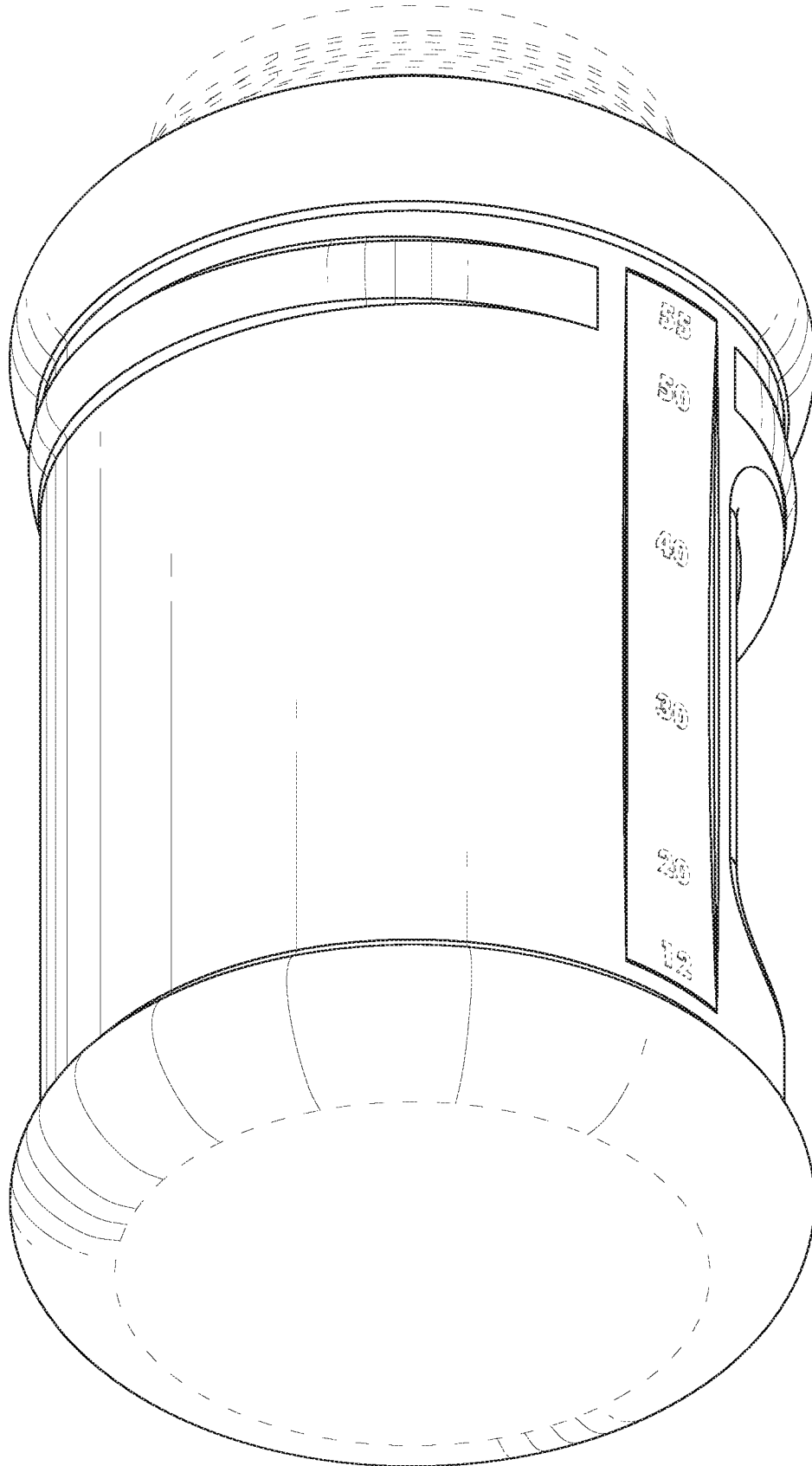

FIG. 2

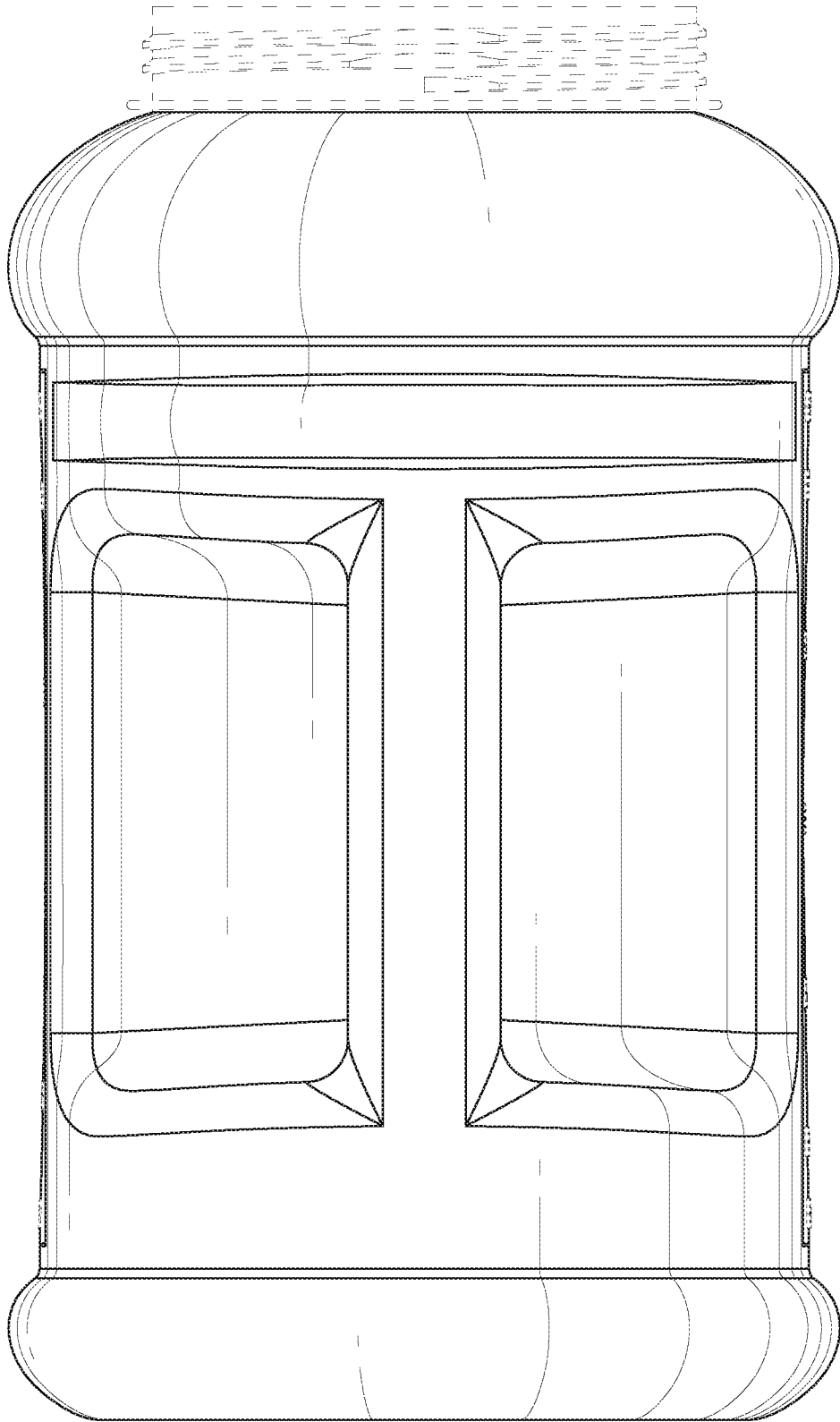

FIG. 3

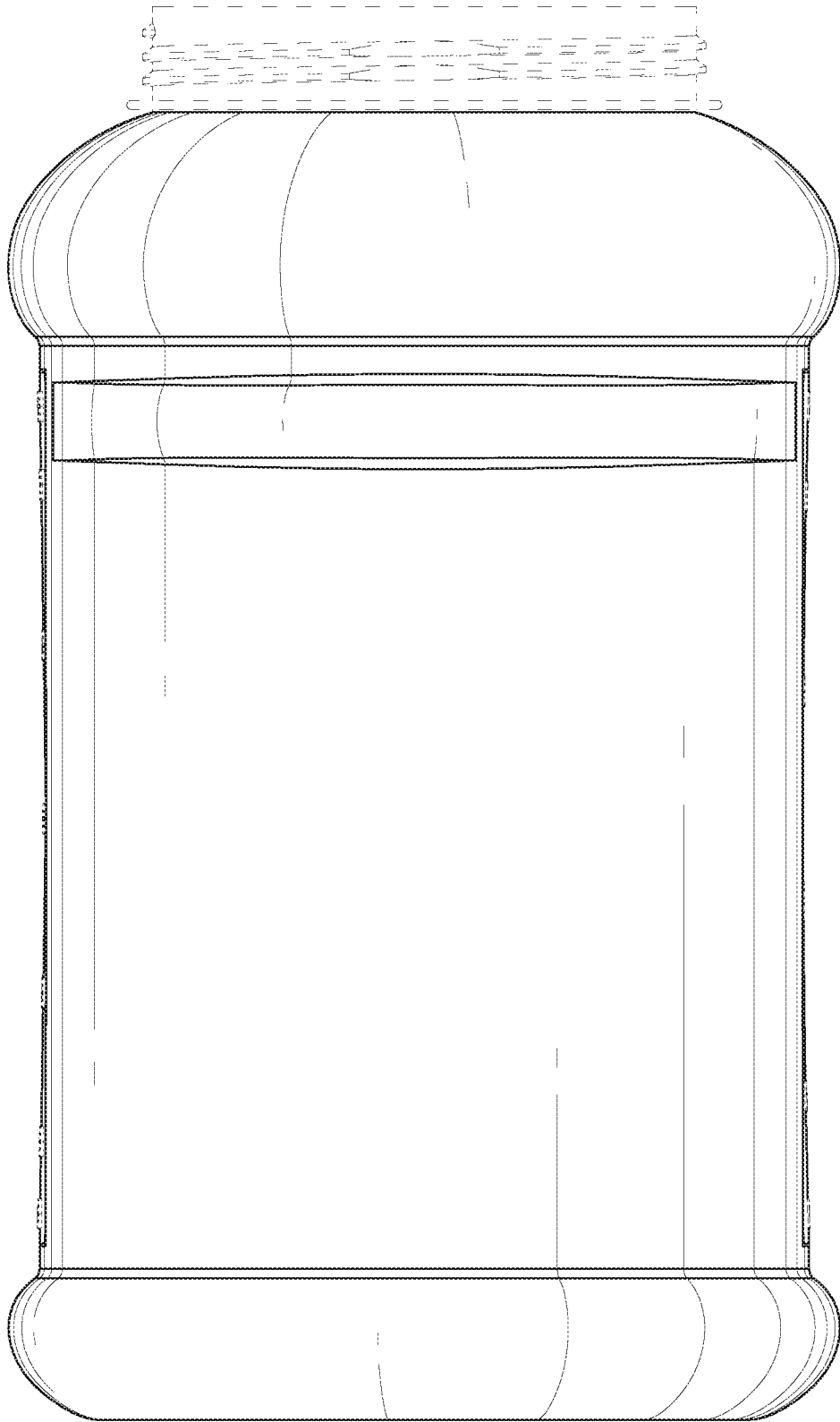

FIG. 4

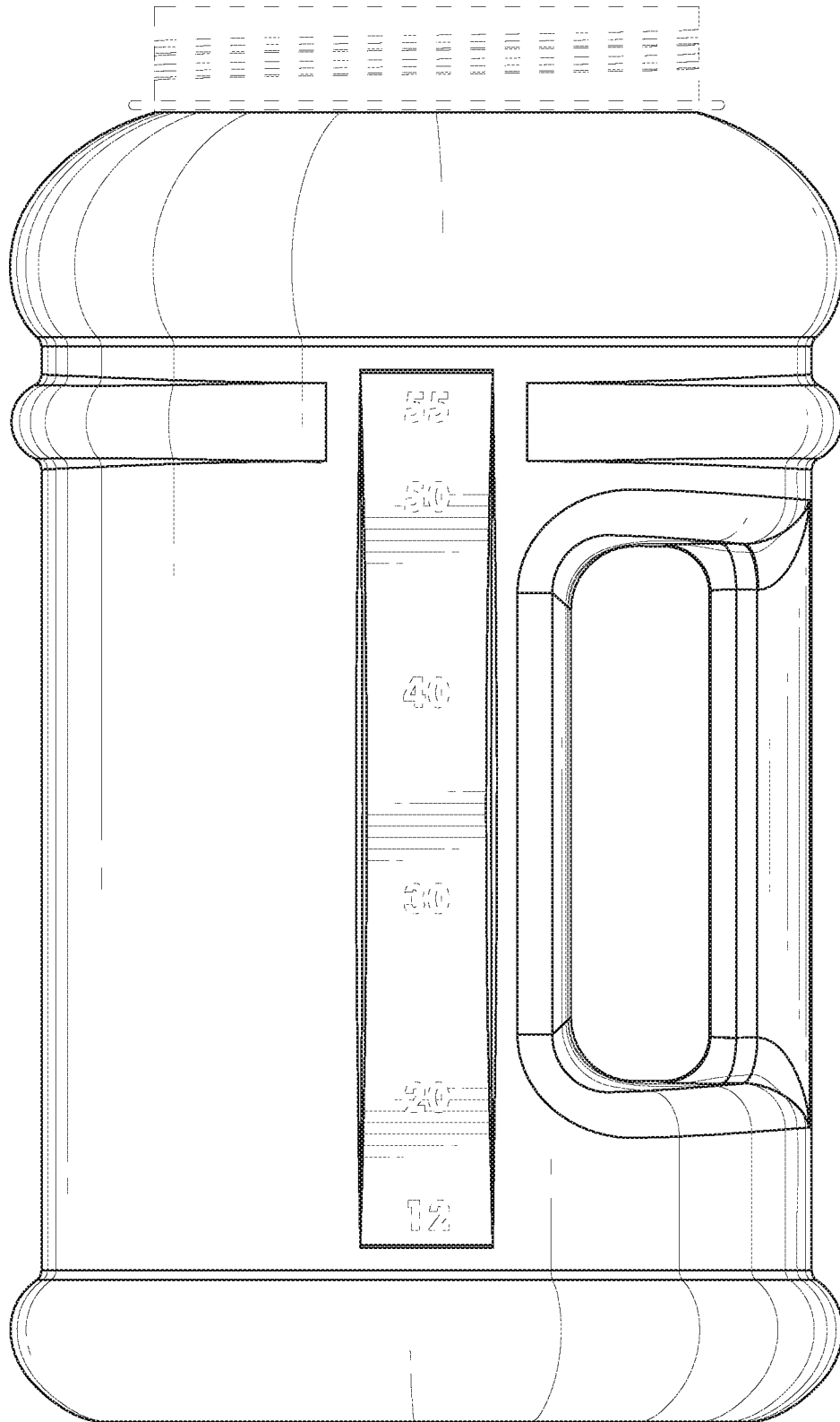

FIG. 5

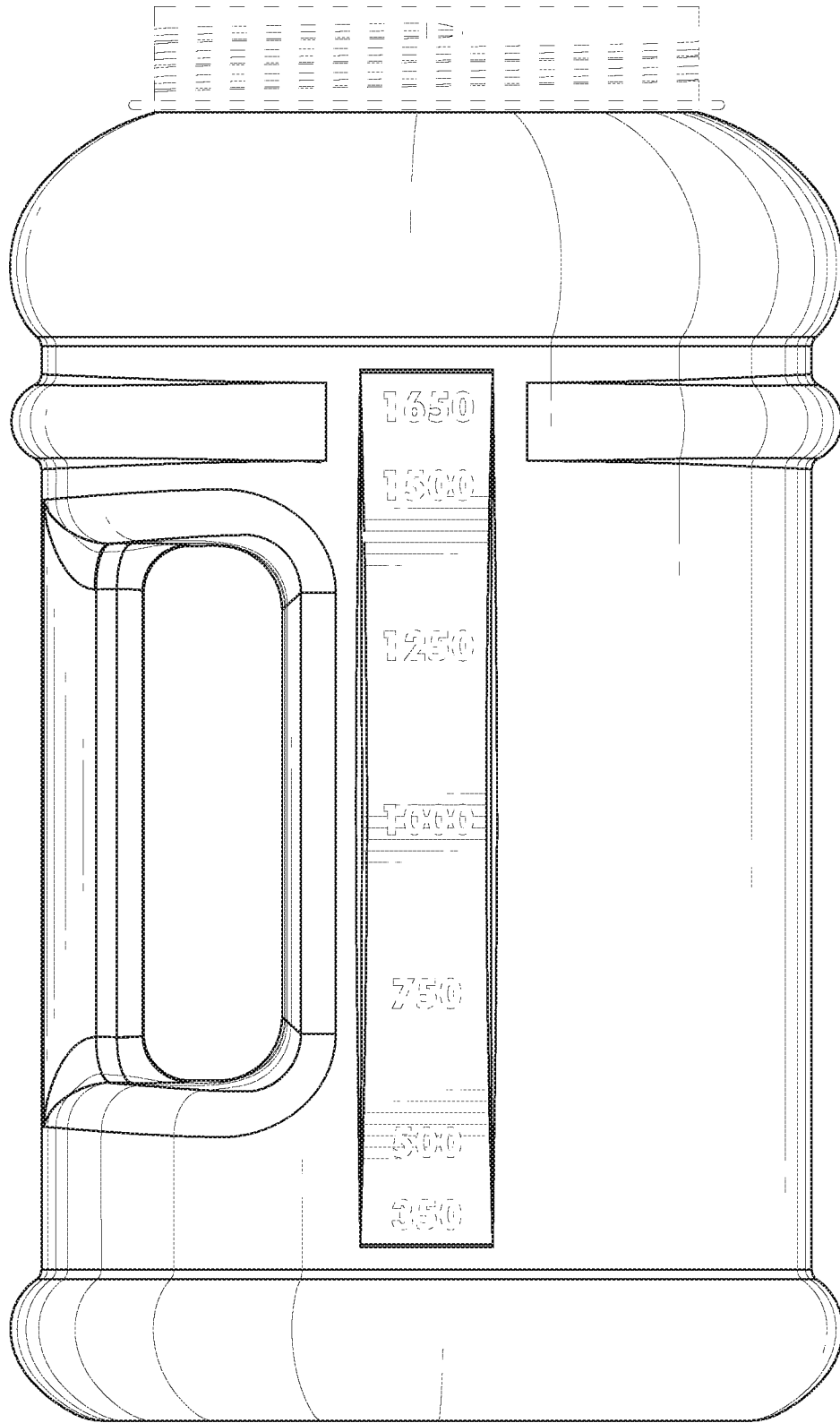

FIG. 6

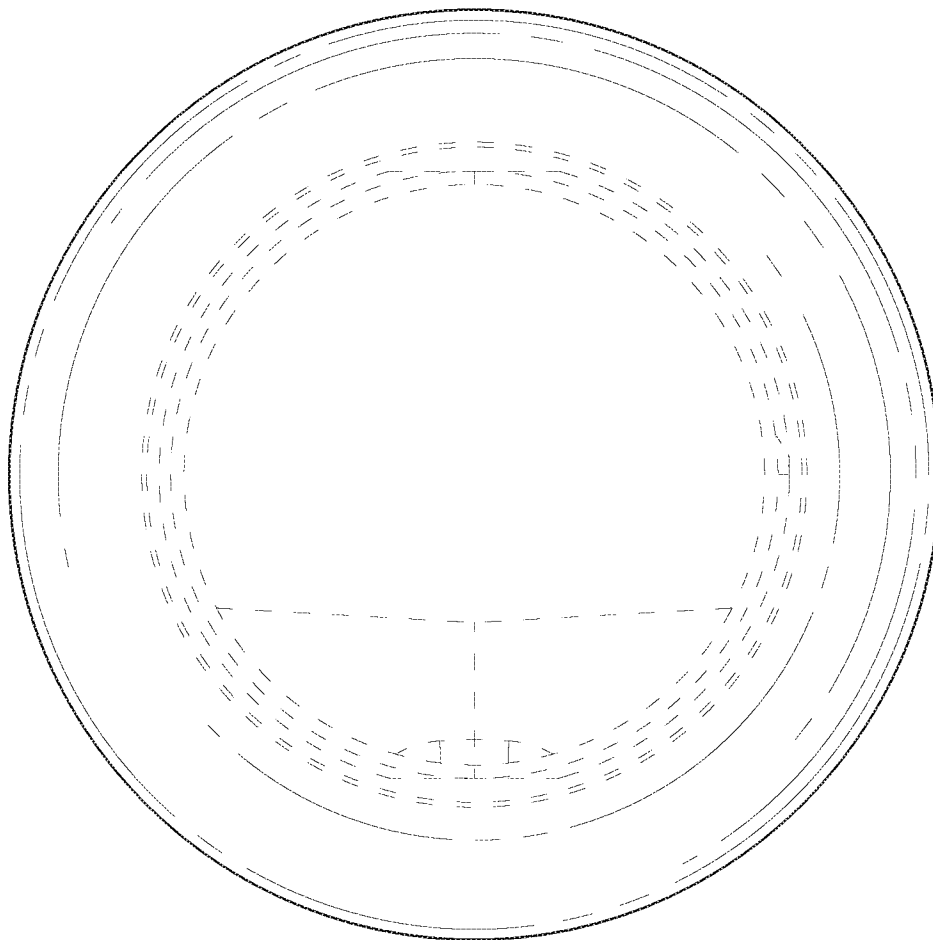

FIG. 7

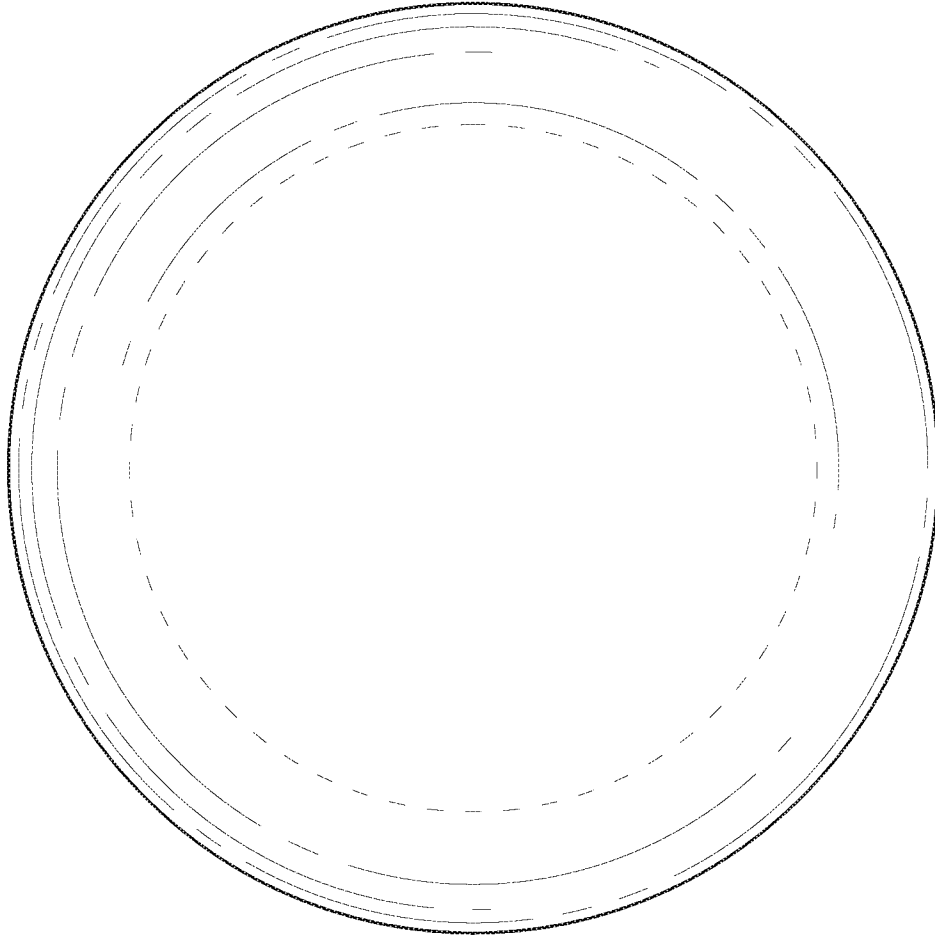

FIG. 8